



DIAMMAX

2025 CATALOG

HOME OF THE #1 BRANDS IN STONE

TO OUR ESTEEMED CUSTOMERS AND LOYAL DISTRIBUTORS,

29 years in any industry is quite an achievement. There is no way we get to this mile stone without the loyalty of our fabricators & distributors. It is this trust that drives to deliver the most consistent performing tools in the industry without delay. To be a leader in any industry requires innovation & next year is not different.

In 2025 our customers can expect Diamax to answer the call for faster working tools for porcelain slabs. Not only have we expanded our Dekton approved **Cyclone Ultra** lines, but we are also introducing the **Super Cyclone** silent core blade for **40% faster cutting** on porcelain! Without using extreme RPMs at a rate of 100"/minute, fabricating porcelain is now faster & more profitable. The fabricator's health and safety are always part of our design process. We have made improvements to our RockBuster to remove grinding stones from shops across the country. We ask all distributors & fabricators a like to follow us for our latest product releases on Instagram at [diamaxinc](https://www.diamaxinc.com). It's a quick and easy way to view the innovations we are currently implementing into the stone industry.

At Diamax, we strive to be a key ally with all our distributors through tireless support & service. There are no long term relationships without being number one in service. Thank you for letting us serve you for 29 amazing years, and we honestly feel we are just getting started in 2025.

Sincerely,
Justin & Simon Hong
Founders
Diamax Industries Inc.



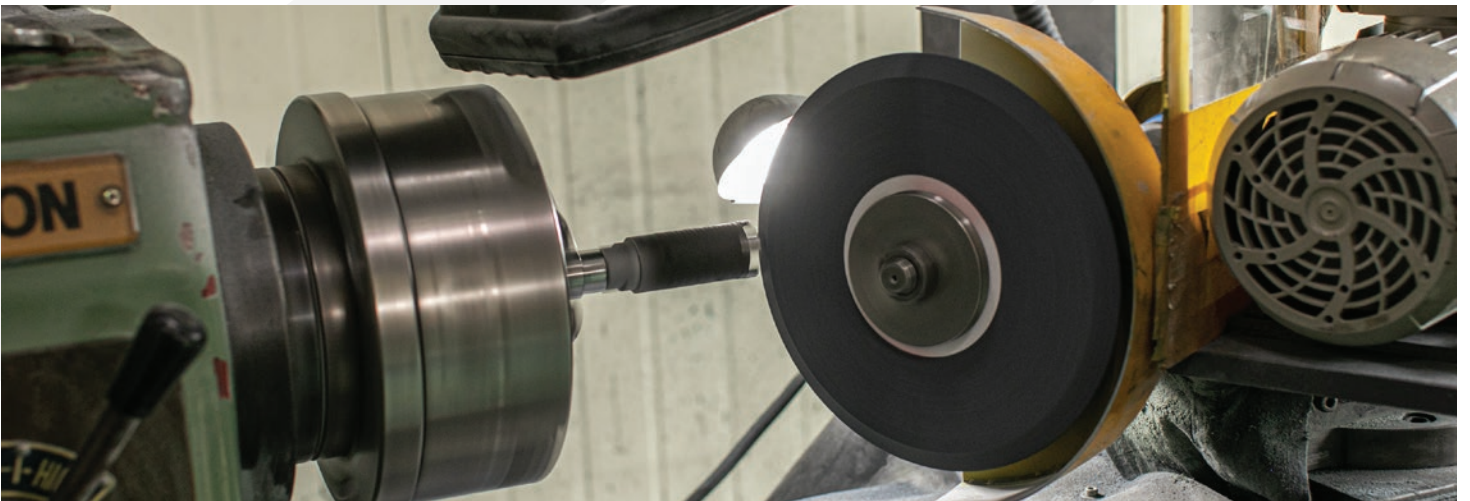

TABLE OF CONTENTS

01 BLADES

- 02 Cyclone QZT Quartzite Blade
- 02 Cyclone Ultra
- 03 Cyclone S Super Q Silent Core
- 03 Cyclone S Silent Core
- 04 Super Cyclone Porcelain Blade
- 04 Cyclone Silent Core Blade
- 05 Hurricane Silent Core
- 05 Cyclone Low Horsepower Blade
- 05 Cyclone Marble Silent Core Blade
- 06 Cyclone S Arrowtek Turbo Blade
- 06 Cyclone Side Segment Turbo Blade
- 06 QZT Turbo
- 07 Cyclone Turbo Blade
- 07 Hurricane Turbo Blade
- 07 Typhoon Turbo Blade
- 08 Super Cyclone Electroplated Blade
- 08 Cyclone Electroplated Blade
- 09 Cyclone Contour Blade
- 09 Hurricane Contour Blade
- 09 Cyclone Electroplated Contour Blade

11 WET POLISHING

- 12 Cyclone Ultra Wet Polishing System
- 13 Trifecto Polishing System
- 13 Hurricane 3 Step Wet Polishing System
- 14 Cyclone Wet Polishing System Superflex Series
- 14 Cyclone Wet Polishing System S-Series
- 14 Cyclone Wet Polishing System R-Series
- 14 3.5 Cyclone Wet Polishing System R-Series
- 15 Hurricane Wet Polishing System RE Series
- 15 Hurricane Wet Polishing System WE Series
- 15 Typhoon Clover Polishing System
- 16 Typhoon Wet Polishing System
- 16 Cyclone Mini-Polishing Drum Sleeve & Adapter
- 16 Cyclone Polishing Convex Disk
- 16 Cyclone Polishing Drum Wheel

17 ENGINEERED STONE (ES) POLISHING

- 18 Cyclone Hybrid 3 Step White Polishing System
- 18 Hurricane ES White 3 Step Polishing System
- 19 Cyclone ES White 7 Step Polishing System
- 19 Hurricane ES White 7 Step Polishing System
- 20 Typhoon ES White 3 Step Polishing System
- 20 Typhoon ES White 7 Step Polishing System

21 DRY POLISHING

- 22 Cyclone Ultra Wet / Dry Polishing
- 22 Dryflex III
- 23 Dryflex Dry Polishing System
- 23 Dryflex 5 Polishing System
- 23 Dryflex II Dry Polishing System
- 23 Diaflex Dry Polishing System
- 24 Cyclone Dry Polishing System
- 24 Typhoon Dry Polishing System
- 24 Hurricane Dry Polishing System

25 CORE DRILL BITS

- 26 Cyclone Dry Core Bit with Inside/Outside Protection
- 26 Cyclone S Thin Wall Core Bit
- 26 Cyclone Turbo Dry Core Bit with Side Diamonds
- 26 Cyclone Vacuum Brazed Core Bit
- 27 Cyclone S QZT Core Bit with Inside/Outside Protection
- 28 Cyclone Ultra Core Bit
- 28 Cyclone Ultra Non Core Bit
- 29 Cyclone Dry Non-Coring Bit
- 29 Cyclone Dry/Wet Core Bit
- 30 Hurricane Dry Core Bit
- 30 Typhoon Dry Core Bit

31 ULTRA-COMPACT

32 DEKTON APPROVED

33 TOOLS

- 34 Cyclone Pneumatic Air Grinder
- 36 Cyclone MVP Pneumatic Air Polisher
- 37 Hurricane Pneumatic Air Polisher

39 GRINDERS / SHAPERS

- 40 Super Cyclone Multi Cutter
- 40 Cyclone S RockBuster
- 40 Cyclone S Resin Cup Wheel
- 41 Cyclone Hex Flat Resin Cup Wheel
- 41 Cyclone Flat Resin Cup Wheel
- 41 Cyclone Ultra Cup Wheel
- 41 Cyclone Turbo Cup Wheel
- 42 Hurricane Cup Wheel
- 42 Cyclone V1 Cutter/Grinder
- 42 Diamond Cone
- 42 Cyclone V2 Grinder
- 44 Cyclone Zero Tolerance Wheel
- 44 Cyclone Stock Removal Wheel

- 44 Cyclone Brazed Stock Removal Wheel
- 45 Cyclone Router Bit Series
- 45 Cyclone Demi Bull Router Bit
- 45 Cyclone Ogee Router Bit
- 45 Cyclone Breaker Bit
- 45 Cyclone Full Bull Router Bit
- 45 Cyclone Bevel Router Bit
- 46 Hurricane Router Bit Series
- 46 Hurricane Half Bull Router
- 46 Hurricane Demi Bull Router
- 46 Hurricane Bevel Router
- 46 Hurricane Ogee Router
- 47 Hurricane Router Bit Series
- 47 Hurricane Waterfall Router
- 47 Hurricane Dupont Router
- 47 Hurricane Cove Router
- 47 Hurricane Cove Dupont Router
- 48 Hurricane Router Bit Series
- 48 Hurricane Pencil Router
- 48 Hurricane Cove/Ogee Router
- 48 Hurricane Double Eased Router
- 48 Hurricane Full Bull Router

49 CONCRETE

- 49 Cluster Pucks
- 49 Cyclone Diamond Cluster Grinding Wheel
- 49 Cyclone PCD (polycrystalline diamond) Wheel

51 CNC TOOLING

- 52 Cyclone Ultra CNC Core Bit
- 52 Cyclone CNC Core Bit
- 52 Cyclone S Thin Wall
- 53 Cyclone Ultra CNC Finger Bit
- 53 Super Cyclone High-Speed Finger Bit
- 53 Cyclone Finger Bit
- 54 Cyclone Combo Finger Bit
- 54 Cyclone Z Wheel
- 54 Cyclone CNC Calibrating Wheel
- 55 Cyclone Incremental Bit & Mandrel
- 56 Cyclone Ultra Incremental Bit

57 AUTO MACHINE TOOLING

- 58 Cyclone Ultra Straight Edge Snail Lock Wheel
- 58 Cyclone Ultra Straight Edge Velcro Wheel
- 59 Cyclone S Hybrid Wheels
- 59 Cyclone Straight Edge Wheels
- 59 Cyclone White Straight Edge Wheels
- 61 Cyclone Copper Edge Wheel
- 61 Cyclone Snail Lock System

63 TILE / GLASS

- 64 Cyclone Ultra Mesh Turbo Blade
- 65 Cyclone Ultra Core Bit
- 65 Cyclone Porcelain Tile Bit
- 66 Cyclone Porcelain Turbo Blade
- 66 Cyclone Electroplated Pad
- 66 Cyclone Continuous Rim Blade
- 66 Cyclone Continuous Rim Glass Blade

67 ACCESSORIES

- 67 Adapters
- 67 Cyclone Backer Pads
- 67 Apron

69 TROUBLESHOOTING

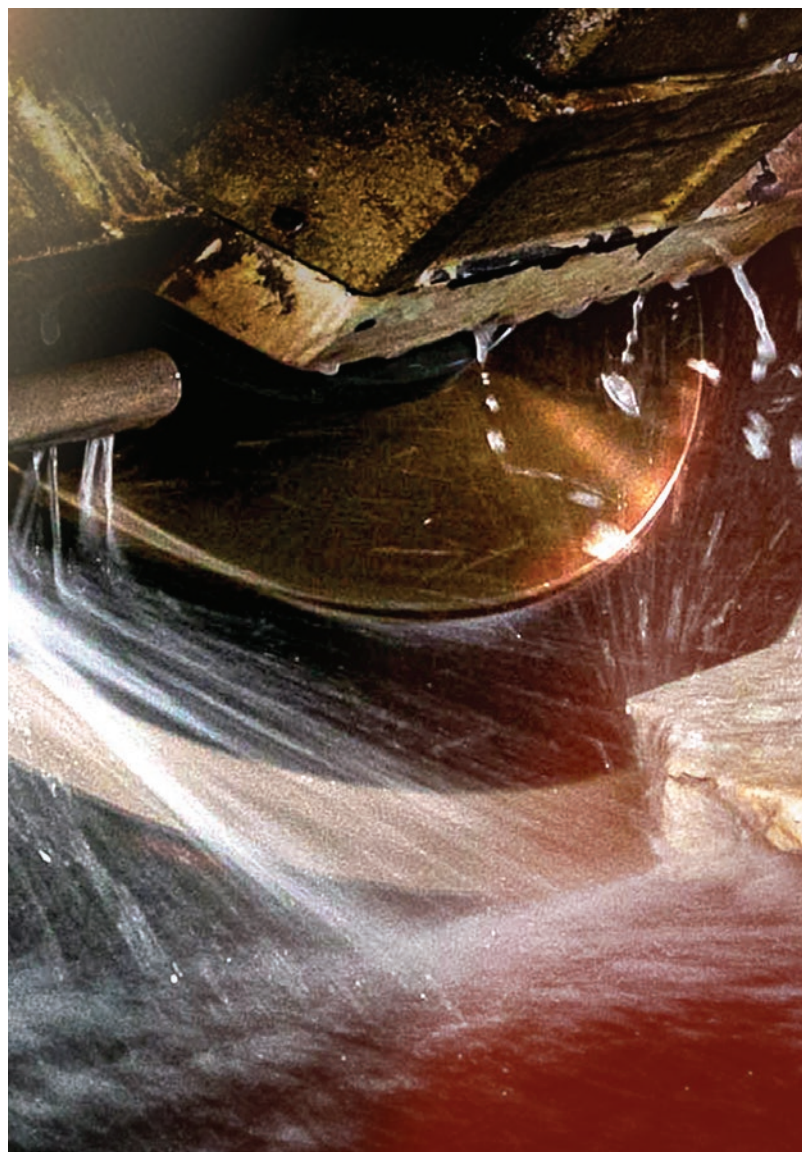

WHAT'S NEW FROM DIAMAX



PG 04

**SUPER CYCLONE
PORCELAIN BLADE**



PG 54

**COMBO
FINGER BIT**

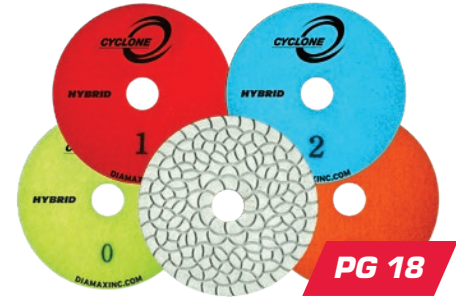

PG 18

**CYCLONE HYBRID
PADS 3 STEP**



PG 49

CLUSTER PUCKS



PG 22

DRYFLEX III



PG 05

HURRICANE BLADE

New 25mm size available



PG 27, 28

**QZT & ULTRA
CORE BITS**



PG 66

**CYCLONE PORCELAIN
TURBO BLADE**

New 3.5" size available

BRIDGE SAW BLADE FEED RATES



CYCLONE S #SCDA S

SIZE	QUARTZITE	GRANITE / ES	DEKTON	RPM
14"	118" min MAX	200" min MAX	—	1900
16"	118" min MAX	200" min MAX	—	1750
18"	118" min MAX	200" min MAX	—	1700
Miter	74" min MAX	—	—	



CYCLONE QZT #SCQ2

SIZE	QUARTZITE	GRANITE / ES	DEKTON	RPM
14"	72" min MAX	120" min MAX	—	1900
16"	72" min MAX	120" min MAX	—	1800
18"	72" min MAX	120" min MAX	—	1700
Miter	42" min MAX	74" min MAX	—	



CYCLONE ULTRA #CUCS

SIZE	QUARTZITE	GRANITE / ES	DEKTON	RPM
14"	35 - 70" min MAX	—	35 - 70" min MAX	2000
16"	35 - 70" min MAX	—	35 - 70" min MAX	2000
18"	35 - 70" min MAX	—	35 - 70" min MAX	1800
Miter	12 - 30" min MAX	—	12 - 30" min MAX	



CYCLONE SILENT CORE BLADE #SCDA

SIZE	QUARTZITE	GRANITE / ES	DEKTON	RPM
12"	—	200" min MAX	—	1600 - 1800
14"	—	200" min MAX	—	1400 - 1600
16"	—	200" min MAX	—	1200 - 1400
18"	—	200" min MAX	—	1000 - 1200
Miter	—	150" min MAX	—	



CYCLONE SUPER Q #SCQU

SIZE	QUARTZITE	GRANITE / ES	DEKTON	RPM
14"	118" min MAX	225" min MAX	—	1900
16"	118" min MAX	225" min MAX	—	1750
18"	118" min MAX	225" min MAX	—	1700
Miter	74" min MAX	175" min MAX	—	



HURRICANE SILENT CORE #HSCB

SIZE	QUARTZITE	GRANITE / ES	DEKTON	RPM
14"	90" min MAX	150" min MAX	—	1900
16"	90" min MAX	150" min MAX	—	1750
18"	90" min MAX	150" min MAX	—	1700



SUPER CYCLONE PORCELAIN BLADE #CUSU

SIZE	QUARTZITE	GRANITE / ES	DEKTON	RPM
14"	—	—	80" / MIN	2400
16"	—	—	80" / MIN	1750
Miter	—	—	48" / MIN	

BLADES



KEY FEATURES

Less than 1% return ratio
on all turbo blade lines

Evolving Technology to
cut the hardest materials

Flawless, straight
cuts every time

Performance you can trust



BLADES

CYCLONE QZT QUARTZITE BLADE

All new bond built for speed & reliability!

Segment designed to keep a square edge during miter cuts

Best blade in the industry to reduce production bottlenecks with fast cuts and clean edges

Only one pass needed! See speed and feed rates below for single pass cutting

Donatoni, Denver, Breton pin holes standard on 16" blade

TOOLS: BRIDGE SAW

MATERIALS: ENGINEERED STONE, GRANITE, MARBLE, QUARTZITE

ITEM #	SIZE	SEGMENT	ARBOR	RPM	STRAIGHT*	MITER*
SCQ21420	14"	20mm x 3.3mm	50/60mm	1900	72" / min	42" / min
SCQ21620	16"	20mm x 3.3mm	50/60mm	1800	72" / min	42" / min
SCQ21820	18"	20mm x 3.3mm	50/60mm	1700	72" / min	42" / min



Donatoni, Denver, Breton pin holes standard on 16" blade

*Feed rates based on single pass in quartzite.

SUGGESTED FEED RATE

CYCLONE ULTRA

Minimal upkeep; limited dressing

Excellent finish for straight AND miter cuts

Silent steel core for noise reduction and cutting efficiency

Precision factory dressing and diamond bonding for minimal load while cutting

Donatoni, Denver, Breton pin holes standard on 16" blade

TOOLS: BRIDGE SAW

MATERIALS: MARBLE, QUARTZITE, ULTRA-COMPACT

ITEM #	SIZE	SEGMENT	ARBOR	RPM	STRAIGHT*	MITER*
CUCS14	14"	10mm	60/50mm	2000	35" - 70" / min	30" - 12" / min
CUCS16	16"	10mm	60/50mm	2000	35" - 70" / min	30" - 12" / min
CUCS18	18"	10mm	60/50mm	1800	35" - 70" / min	30" - 12" / min



Donatoni, Denver, Breton pin holes standard on 16" blade

SUGGESTED FEED RATE

CYCLONE S SUPER Q SILENT CORE

Blade can be used for straight and miter cuts with minimal noise

Reinforced core allows for miter cuts up to 40% of speed of straight cuts

U-shaped segment design for faster speed and no glazing



TOOLS: BRIDGE SAW

MATERIALS: ENGINEERED STONE, GRANITE, QUARTZITE

ITEM #	SIZE	SEGMENT	ARBOR	RPM	STRAIGHT	MITER
SCQU1420	14"	20mm x 3.2mm	50/60mm	1900	118"/min	74"/min
SCQU1620	16"	20mm x 3.2mm	50/60mm	1750	118"/min	74"/min
SCQU1820	18"	20mm x 3.2mm	50/60mm	1700	118"/min	74"/min

60% Feed rate for miter cutting.

SUGGESTED FEED RATE

CYCLONE S SILENT CORE

Now one blade for straight cuts and miters

New reengineered segment gives faster, cleaner and straighter miter cuts

New reinforced core does not flex or lose tension when cutting miters

Miter or straight cut clean edges on material ranging from marble to quartzite*

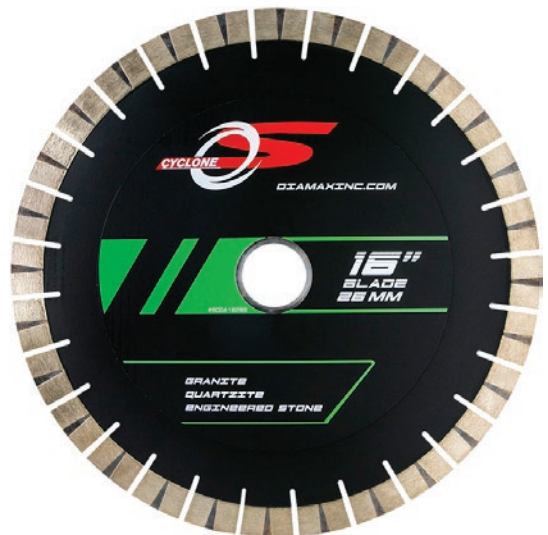

TOOLS: BRIDGE SAW

MATERIALS: ENGINEERED STONE, GRANITE, MARBLE, QUARTZITE

ITEM #	SIZE	SEGMENT	ARBOR	RPM	MAX FEED RATE
SCDA1420S	14"	20mm	50/60mm	1900	21' / min
SCDA1426S	14"	26mm	50/60mm	1900	21' / min
SCDA1620S	16"	20mm	50/60mm	1750	21' / min
SCDA1626S	16"	26mm	50/60mm	1750	21' / min
SCDA9016S	16"	26mm	50/60mm	1750	21' / min
SCDA1826S	18"	26mm	50/60mm	1700	21' / min

* Proper dressing needed when cutting materials with varying densities

BLADES

SUPER CYCLONE PORCELAIN BLADE

15% thinner segment to create faster and cleaner cuts!

Precision factory dressing so you never have to!

Thin segment with reinforced core for perfect miter edges

Donatoni, Denver, Breton pin holes standard on 16" blade

TOOLS: BRIDGE SAW

MATERIALS: DEKTON, NEOLITH, TECHLAM, LAMINAM, ULTRA-COMPACT, PORCELAIN

ITEM #	SIZE	SEGMENT	ARBOR	RPM	STRAIGHT	MITER
CUSU14	14"	10mm	50/60mm	2400	80°/min	48°/min
CUSU16	16"	10mm	50/60mm	2200	80°/min	48°/min



Donatoni, Denver,
Breton pin holes
standard on 16" blade

CATEGORY 5 SPEEDS

SIZE	DEKTON / PORCELAIN	MITER	RPM
16"	120° / min	48°/min	2400

***70% FEED RATE FOR ENTRY AND EXIT**

CYCLONE SILENT CORE BLADE



9 layers of patterned diamond technology to achieve max performance

Cyclone high-speed diamond allocation technology provides fast cutting (SCDA)

Choose from 20mm or 26mm segments

TOOLS: BRIDGE SAW

MATERIALS: ENGINEERED STONE, GRANITE, MARBLE

ITEM #	SIZE	SEGMENT	ARBOR	RPM
SCDA1220	12"	20mm	50/60mm	1600 - 1800
SCDA1420	14"	20mm	50/60mm	1400 - 1600
SCDA1426	14"	26mm	50/60mm	1400 - 1600
SCDA1620	16"	20mm	50/60mm	1200 - 1400
SCDA1626	16"	26mm	50/60mm	1200 - 1400
SCDA1690	16"	26mm	90mm	1200 - 1400
SCDA1826	18"	26mm	50/60mm	1000 - 1200

PARAMETERS FOR CYCLONE S AND CYCLONE SCDA

SIZE	RECOMMENDED RPM	FEED RATE	SUGGESTED HORSEPOWER
12"	1800	10 -17 ft/min	10 - 20
14"	1600	10 -17 ft/min	10 - 20
16"	1400	10 -17 ft/min	15 - 25
18"	1200	10 -17 ft/min	20 - 25

BLADES

HURRICANE SILENT CORE

Cost-effective high-performance blade

Versatile segment for fast cutting from Quartzite to Engineered Stone

Same performance from 10 - 25hp saw

Capable of high feed rates with 2000+ RPMs!

The highest ROI of any blade on the market!

TOOLS: BRIDGE SAW

MATERIALS: ENGINEERED STONE, GRANITE, QUARTZITE

ITEM #	SIZE	SEGMENT	ARBOR	RPM
HSCB1420	14"	20mm	50/60mm	1900
HSCB1620	16"	20mm	50/60mm	1750
HSCB1820	18"	20mm	50/60mm	1700
HSCB1425	14"	25mm	50/60mm	1900
HSCB1625	16"	25mm	50/60mm	1750
HSCB1825	18"	25mm	50/60mm	1700

CATEGORY 5 SPEEDS

SIZE	ES / GRANITE	QUARTZITE	RPM
16"	226" / min	120" / min	2200



NEW SIZES

Donatoni, Denver,
Breton pin holes
standard on 16" blade

CYCLONE LOW HORSEPOWER BLADE

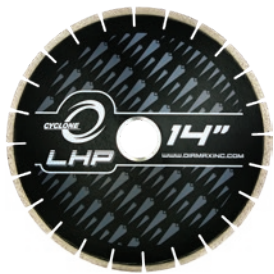

First ever low horsepower (LH) blade designed with a silent core

Designed for the Achilles, Blue Ripper, TSA or any portable track saw device

Special soft bond cuts super hard material with ease

CYCLONE MARBLE SILENT CORE BLADE



Designed with a specific marble bond segment

Segments contain a higher concentration of smaller grit diamonds to insure chip-free clean cutting

The silent core feature reduces noise significantly

Performs clean and straight miter cuts

TOOLS: BRIDGE SAW

MATERIALS: ENGINEERED STONE, GRANITE, QUARTZITE

ITEM #	SIZE	SEGMENT	BOND	ARBOR	RPM
SCLH14	14"	10mm	Soft	50/60mm	1400 - 1600
SCLH16	16"	10mm	Soft	50/60mm	1200 - 1400
SCSB1415	14"	15mm	Soft	50/60mm	1400 - 1600
SCSB1615	16"	15mm	Soft	50/60mm	1200 - 1400

TOOLS: BRIDGE SAW

MATERIALS: MARBLE

ITEM #	SIZE	SEGMENT	BOND	ARBOR	RPM
SCMARB14	14"	10mm	Med	50/60mm	2000
SCMARB16	16"	10mm	Med	50/60mm	1800

BLADES

CYCLONE S ARROWTEK TURBO BLADE



The Cyclone Arrowtek design is the next generation of diamond blades

The Arrowtek rim allows this blade to cut faster and cleaner than traditional turbo blades on hard materials

TOOLS: ANGLE GRINDER, HAND SAW
MATERIALS: ENGINEERED STONE, GRANITE, QUARTZITE

ITEM #	SIZE	ARBOR	MAX RPM
TBA50	5"	5/8" - 7/8" - 20mm	12000
TBA55	5.5"	5/8" - 7/8" - 20mm	10185
TBA60	6"	5/8" - 7/8" - 20mm	10185

CYCLONE SIDE SEGMENT TURBO BLADE



Side segments are fully inlaid within the core for safe cutting

Side segments prevent blade from binding within the stone

Thick solid steel core eliminates any possibility of warping and insures straight cuts

TOOLS: ANGLE GRINDER, HAND SAW
MATERIALS: ENGINEERED STONE, GRANITE, QUARTZITE

ITEM #	SIZE	ARBOR	MAX RPM
SSTB5P	5"	5/8" - 7/8" - 20mm	12000
SSTB6P	6"	5/8" - 7/8" - 20mm	10185
SSTB7P	7"	5/8" - DKO	8730

QZT TURBO



Contains the highest grade of super abrasive diamonds.

9.5mm rim for longer life

Cuts quartzite with ease

TOOLS: ANGLE GRINDER, HAND SAW
MATERIALS: ENGINEERED STONE, GRANITE, QUARTZITE

ITEM #	SIZE	ARBOR	RPM
TBS045	4.5"	5/8" - 7/8" - 20mm	13000
TBS050	5 1/8"	5/8" - 7/8" - 20mm	12000
TBS060	6"	5/8" - 7/8" - 20mm	10185
TBS070	7"	5/8" - 7/8" - 20mm	8730

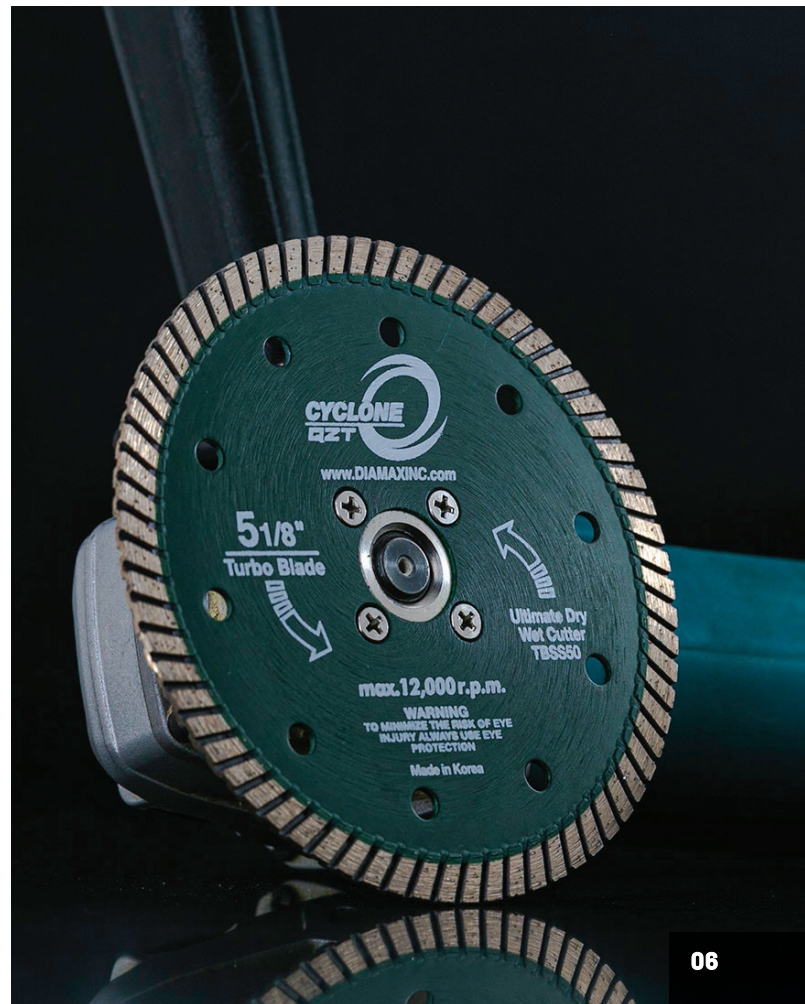

BLADES

CYCLONE TURBO BLADE



Laboratory tested to dry cut 118 linear feet of 3 cm absolute black granite

The #1 selling turbo blade in America

7" and 8" blades now have a thicker core which make for straighter cuts and they are silent

TOOLS: ANGLE GRINDER, HAND SAW
MATERIALS: ENGINEERED STONE, GRANITE

ITEM #	SIZE	ARBOR	MAX RPM
TBS40	4"	5/8" - 7/8" - 20mm	15000
TBS45	4.5"	5/8" - 7/8" - 20mm	13000
TBS50	5"	5/8" - 7/8" - 20mm	12000
TBS60	6"	5/8" - 7/8" - 20mm	10185
TBSC70	7"	5/8" - DKO, Silent core	8730
TBS7Q	7"	5/8" - 7/8" - 20mm	8730
TBSC80	8"	5/8" - DKO, Silent core	7640

HURRICANE TURBO BLADE



Cuts like a Cyclone at a more affordable price

Softer bond for faster cutting

Still maintains a return ratio of less than 1% over the last 13 years

TOOLS: ANGLE GRINDER, HAND SAW
MATERIALS: ENGINEERED STONE, GRANITE

ITEM #	SIZE	ARBOR	MAX RPM
HTB40	4"	5/8" - 7/8" - 20mm	15,000
HTB45	4.5"	5/8" - 7/8" - 20mm	13000
HTB50	5"	5/8" - 7/8" - 20mm	12000
HTB60	6"	5/8" - 7/8" - 20mm	10185
HTB70	7"	5/8" - DKO	8730
HTB7Q	7"	5/8" - 7/8" - 20mm	8730
HTB80	8"	5/8" - DKO	7640

TYPHOON TURBO BLADE



New bond with additional diamonds offers even faster cutting and an extended life

Fast, smooth cut throughout the life of the blade

Cleanest cutting economy turbo blade in the industry

Can cut up to 1000+ feet when used with water

TOOLS: ANGLE GRINDER, HAND SAW
MATERIALS: ENGINEERED STONE, GRANITE, MARBLE

ITEM #	SIZE	ARBOR	MAX RPM
TBT40	4"	5/8" - 7/8"	15000
TBT45	4.5"	5/8" - 7/8"	13000
TBT50	5"	5/8" - 7/8"	12000
TBT60	6"	5/8" - 7/8"	10185
TBT70	7"	5/8" - DKO	8730



BLADES

SUPER CYCLONE ELECTROPLATED BLADE



Thick enough for quad adapters

First marble blade with vortex side protection

Cuts engineered glass composite materials

Side protection ensures a clean 90° cut

Cleanest cutting Dekton blade on the market

TOOLS: ANGLE GRINDER, HAND SAW

MATERIALS: MARBLE, PORCELAIN/TILE, ULTRA-COMPACT

ITEM #	SIZE	ARBOR	RPM
EMBSL40	4"	5/8" - 7/8" - 20mm	15000
EMBSL45	4.5"	5/8" - 7/8" - 20mm	13300
EMBSL50	5"	5/8" - 7/8" - 20mm	12000
EMBSL60	6"	5/8" - 7/8" - 20mm	10185
EMBSL70*	7"	5/8" - DKO	8730
EMBSL70	7"	5/8" - 7/8" - 20mm	8730

* Comes with DKO and 4 holes

CYCLONE ELECTROPLATED BLADE



Thin core allows for sharp, clean cuts in all marbles

Special electroplating process separates this blades performance from all others

For straight cuts only

TOOLS: ANGLE GRINDER, HAND SAW

MATERIALS: MARBLE, PORCELAIN/TILE, ULTRA-COMPACT

ITEM #	SIZE	ARBOR	RPM
EMBL40	4"	5/8" - 7/8" - 20mm	15000
EMBL45	4.5"	5/8" - 7/8" - 20mm	13300
EMBL50	5"	5/8" - 7/8" - 20mm	12000
EMBL60	6"	5/8" - 7/8" - 20mm	10185
EMBL70	7"	5/8" - DKO	8730

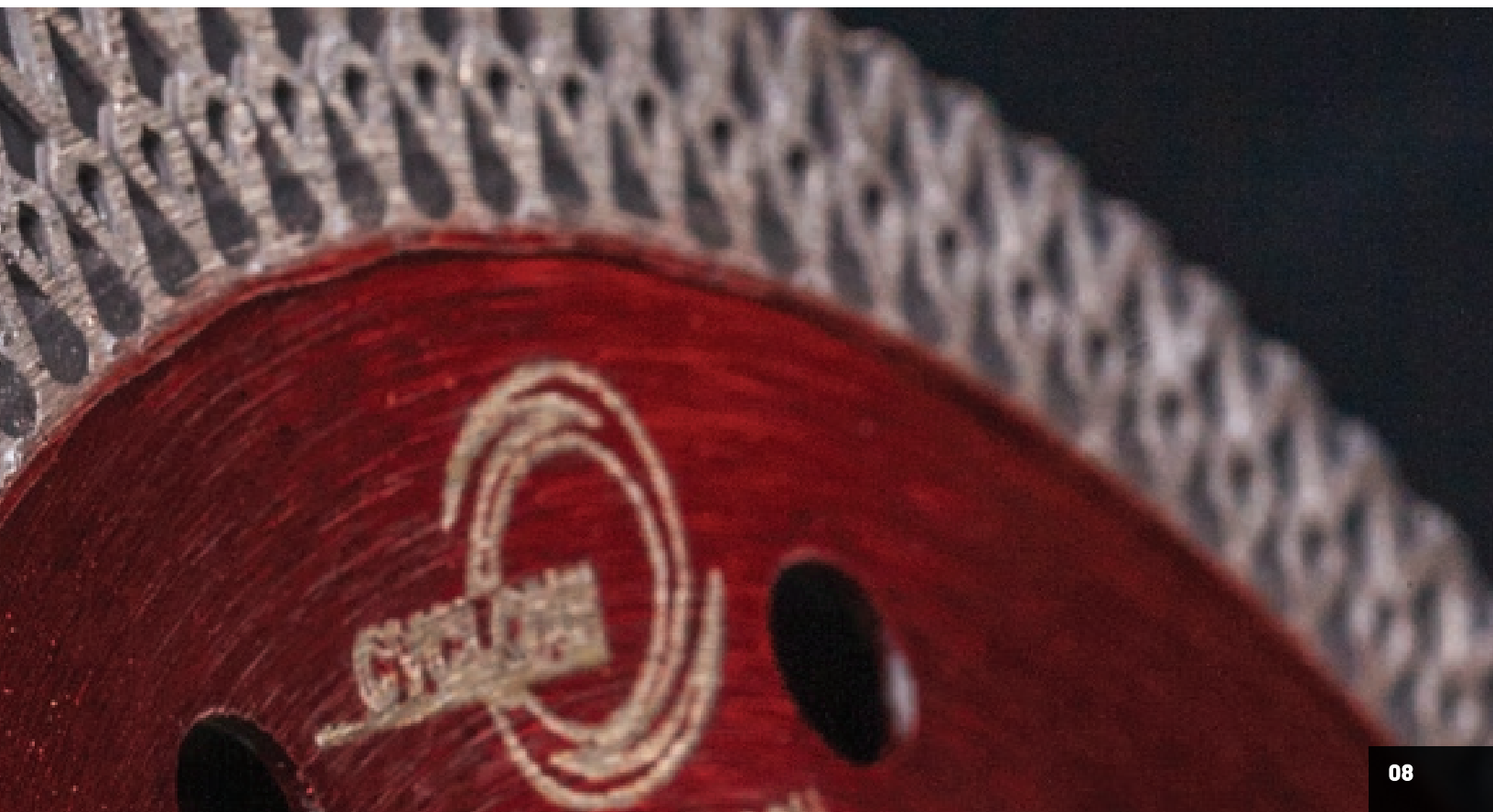

BLADES

CYCLONE CONTOUR BLADE



Vortex side protection designed for faster and smoother cutting

Side protection helps keep cuts smooth and chip-free

Increased segment height for longer life

TOOLS: ANGLE GRINDER, HAND SAW
MATERIALS: ENGINEERED STONE, GRANITE

ITEM #	SIZE	ARBOR	RPM
CTB52	5"	5/8" - 7/8"	12200
CTB62	6"	5/8" - 7/8"	10000

HURRICANE CONTOUR BLADE



Perfect balance ensures smooth entry with your first cut

The turbo-rim produces safer and cleaner cuts than other contour blades

TOOLS: ANGLE GRINDER, HAND SAW
MATERIALS: ENGINEERED STONE, GRANITE

ITEM #	SIZE	ARBOR	MAX RPM
CTBH5	5"	5/8" - 7/8"	12000
CTBH6	6"	5/8" - 7/8"	10000

CYCLONE ELECTROPLATED CONTOUR BLADE



Redesigned with vortex side protection for smoother cutting

Advanced and highly special production process separates Cyclone electroplated products from the rest

Designed for curve-cutting sinks and large radius cut-outs

TOOLS: ANGLE GRINDER, HAND SAW
MATERIALS: MARBLE, PORCELAIN/TILE, ULTRA-COMPACT

ITEM #	SIZE	ARBOR	RPM
CTEB5	5"	5/8" - 7/8"	12000





CYCLONE QZT QUARTZITE BLADE

All new bond built for speed & reliability!

Segment designed to keep a square edge during miter cuts.

Best blade in the industry to reduce production bottlenecks with fast cuts and clean edges.

Only one pass needed!



WET POLISHING



KEY FEATURES

Wet resin velcro
polishing pads available
in 3", 4", and 5"

Options available for
granite, marble &
engineered stone

Always in stock



WET POLISHING

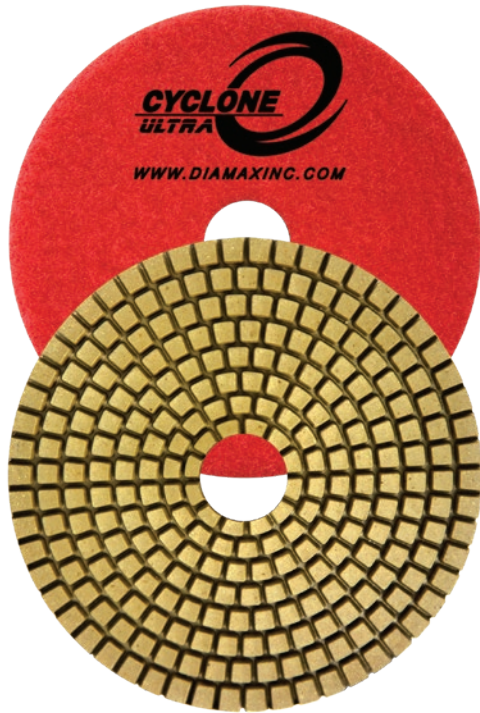

CYCLONE ULTRA WET POLISHING SYSTEM

The Cyclone Ultra is the highest quality wet polishing system produced by Diamax

With its new resin and heavier diamond formula, the Ultra System delivers longer life & minimizes polishing time at a great value

Used to polish all engineered and natural stone materials with minimal resin bleeding

3mm thick resin with R Series Tread

TOOLS: ANGLE GRINDER, AIR POLISHER

MATERIALS: **ENGINEERED STONE, GRANITE**

GRIT	3"	4"	5"	WET ONLY RPM
50	SPD30050	SPD40050	SPD50050	4000
100	SPD30100	SPD40100	SPD50100	4000
200	SPD30200	SPD40200	SPD50200	4000
400	SPD30400	SPD40400	SPD50400	4000
800	SPD30800	SPD40800	SPD50800	4000
1500	SPD31500	SPD41500	SPD51500	4000
3000	SPD33000	SPD43000	SPD53000	4000
Black buff	SPD3BB	SPD4BB	NA	4000
White buff	SPD3BW	SPD4BW	NA	4000



WET POLISHING

TRIFECTO POLISHING SYSTEM

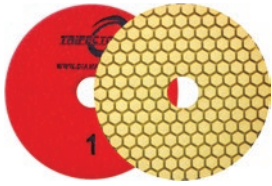

Reduces polishing time by 40% to 50%

Can be used dry but for best results use all 3 steps wet. Start with 120 grit stone, then repeat Pos. 1 with a little water

Achieves the same gloss meter reading of a full system in half the time

TOOLS: ANGLE GRINDER, AIR POLISHER

MATERIALS: ENGINEERED STONE, GRANITE, MARBLE

POS.	ITEM #	SIZE	FITTING	WET/DRY RPM
1	P3D41	4"	Velcro back	4000
2	P3D42	4"	Velcro back	4000
3	P3D43	4"	Velcro back	4000

HURRICANE 3 STEP WET POLISHING SYSTEM

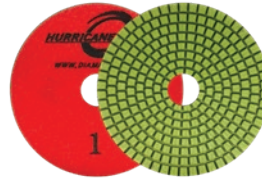

Step "0" removes deep scratches

Reduces polishing time by 40 - 50%

Super diamond concentration removes four polishing steps with an optional zero position

Extremely flexible design allows for use on ogee profiles & other tight corners

TOOLS: ANGLE GRINDER, AIR POLISHER

MATERIALS: ENGINEERED STONE, GRANITE, MARBLE

POS.	ITEM #	SIZE	FITTING	WET ONLY RPM
0	PD4F40	4"	Velcro back	4000
1	PD4F41	4"	Velcro back	4000
2	PD4F42	4"	Velcro back	4000
3	PD4F43	4"	Velcro back	4000



WET POLISHING

CYCLONE WET POLISHING SYSTEM SUPERFLEX SERIES

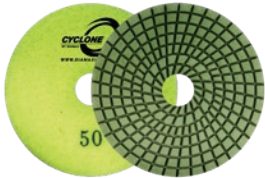

Premium wet polishing disk

Durable and high-performing against the top brands in the industry

Gains flexibility after continual use

3mm thick resin with Superflex tread

TOOLS: ANGLE GRINDER, AIR POLISHER

MATERIALS: **ENGINEERED STONE, GRANITE, MARBLE**

GRIT	3"	4"	5"	WET ONLY RPM
50	PD350SF	PD450SF	PD550SF	4000
100	PD3100SF	PD4100SF	PD5100SF	4000
200	PD3200SF	PD4200SF	PD5200SF	4000
400	PD3400SF	PD4400SF	PD5400SF	4000
800	PD3800SF	PD4800SF	PD5800SF	4000
1500	PD31500SF	PD41500SF	PD51500SF	4000
3000	PD33000SF	PD43000SF	PD53000SF	4000
Black buff	PD3BB	PD4BB	PD5BB	4000
White buff	PD3BW	PD4BW	PD5BW	4000

CYCLONE WET POLISHING SYSTEM R-SERIES



Premium wet polishing disk

Durable and high-performing against the top brands in the industry

Gains flexibility after continual use

3mm thick resin with R Series Tread

TOOLS: ANGLE GRINDER, AIR POLISHER

MATERIALS: **ENGINEERED STONE, GRANITE, MARBLE**

GRIT	3"	4"	5"	WET ONLY RPM
50	PDR350	PDR450	PDR550	4000
100	PDR3100	PDR4100	PDR5100	4000
200	PDR3200	PDR4200	PDR5200	4000
400	PDR3400	PDR4400	PDR5400	4000
800	PDR3800	PDR4800	PDR5800	4000
1500	PDR31500	PDR41500	PDR51500	4000
3000	PDR33000	PDR43000	PDR53000	4000
Black buff	PDR3BB	PDR4BB	NA	4000
White buff	PDR3BW	PDR4BW	NA	4000

CYCLONE WET POLISHING SYSTEM S-SERIES



Premium wet polishing disk

Durable and high-performing against the top brands in the industry

Gains flexibility after continual use

3mm thick resin with S Series Tread

TOOLS: ANGLE GRINDER, AIR POLISHER

MATERIALS: **ENGINEERED STONE, GRANITE, MARBLE**

GRIT	4"	WET ONLY RPM
50	STS450	4000
100	STS4100	4000
200	STS4200	4000
400	STS4400	4000
800	STS4800	4000
1500	STS41500	4000
3000	STS43000	4000

3.5 CYCLONE WET POLISHING SYSTEM R-SERIES

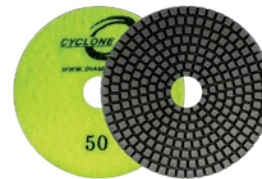

Thicker 3.5mm pads with our highest selling R series tread pattern

Available in 30, 50, 100, 300, 500, 1000, 2000, 3000 grits

Pads may be used interchangeably with other Diamax wet polishing systems

TOOLS: ANGLE GRINDER, AIR POLISHER

MATERIALS: **ENGINEERED STONE, GRANITE, MARBLE**

GRIT	ITEM #	SIZE	FITTING	WET ONLY RPM
30	PDR3530	4"	Velcro back	4000
50	PDR3550	4"	Velcro back	4000
100	PDR35100	4"	Velcro back	4000
300	PDR35300	4"	Velcro back	4000
500	PDR35500	4"	Velcro back	4000
1000	PDR351000	4"	Velcro back	4000
2000	PDR352000	4"	Velcro back	4000
3000	PDR353000	4"	Velcro back	4000

WET POLISHING

HURRICANE WET POLISHING SYSTEM RE SERIES



This wet pad system is the best value in terms of durability, polish, and flexibility

Best selling 3mm pad in our line-up

New 30 grit pad can be used as a substitute for carbide stones to remove deep scratches

3mm thick resin with R Series Tread

TOOLS: ANGLE GRINDER, AIR POLISHER
MATERIALS: ENGINEERED STONE, GRANITE

GRIT	3"	4"	5"	WET ONLY RPM
30	NA	PDRE40030	NA	4000
50	PDRE350	PDRE450	PDRE550	4000
100	PDRE3100	PDRE4100	PDRE5100	4000
200	PDRE3200	PDRE4200	PDRE5200	4000
400	PDRE3400	PDRE4400	PDRE5400	4000
800	PDRE3800	PDRE4800	PDRE5800	4000
1500	PDRE31500	PDRE41500	PDRE51500	4000
3000	PDRE33000	PDRE43000	PDRE53000	4000
Black buff	PDRE3BB	PDRE4BB	PDRE5BB	4000
White buff	PDRE3BW	PDRE4BW	PDRE5BW	4000

HURRICANE WET POLISHING SYSTEM WE SERIES

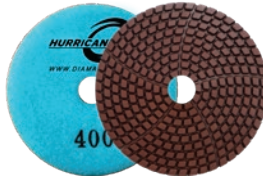

This wet pad system is the best value in terms of durability, polish, and flexibility

3mm thick resin with W Series Tread

TOOLS: ANGLE GRINDER, AIR POLISHER
MATERIALS: ENGINEERED STONE, GRANITE

GRIT	3"	4"	5"	WET ONLY RPM
50	PDWE350	PDWE450	PDWE550	4000
100	PDWE3100	PDWE4100	PDWE5100	4000
200	PDWE3200	PDWE4200	PDWE5200	4000
400	PDWE3400	PDWE4400	PDWE5400	4000
800	PDWE3800	PDWE4800	PDWE5800	4000
1500	PDWE31500	PDWE41500	PDWE51500	4000
3000	PDWE33000	PDWE43000	PDWE53000	4000

TYPHOON CLOVER POLISHING SYSTEM

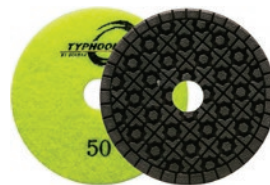

New Clover tread design traps water for a high polish

Pads are highly flexibility with clover tread

Rounded pad edges eliminate any accidental scratches

3mm thick resin

TOOLS: ANGLE GRINDER, AIR POLISHER
MATERIALS: ENGINEERED STONE, GRANITE

GRIT	4"	FITTING	RPM/WET
50	PRC40050	Velcro back	4000
100	PRC40100	Velcro back	4000
200	PRC40200	Velcro back	4000
400	PRC40400	Velcro back	4000
800	PRC40800	Velcro back	4000
1500	PRC41500	Velcro back	4000
3000	PRC43000	Velcro back	4000

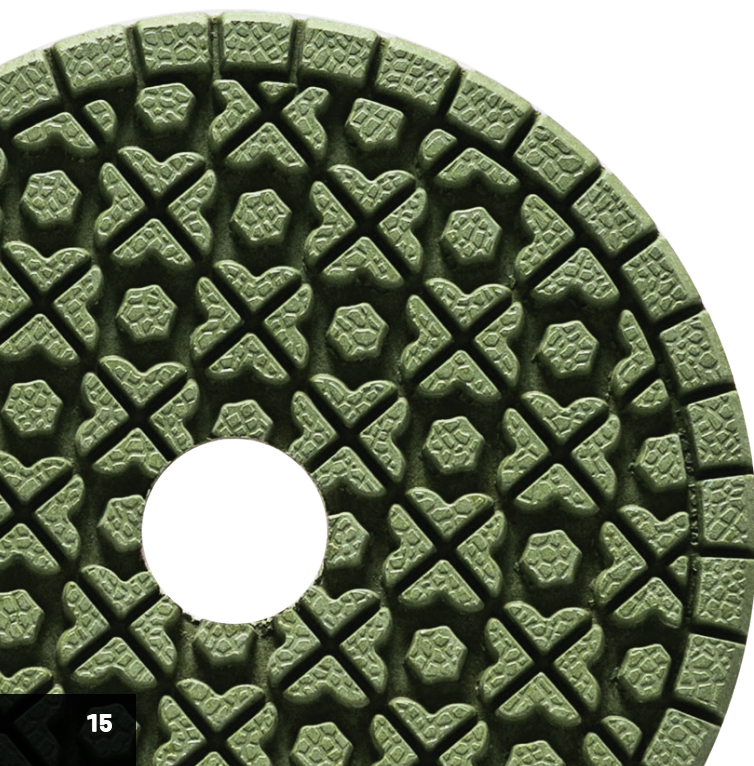

WET POLISHING

TYPHOON WET POLISHING SYSTEM

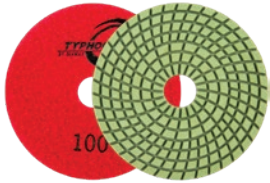

Gives you the best polish in the economy class without sacrificing life

Durable with a spiral design that spreads water efficiently

3mm thick resin

TOOLS: ANGLE GRINDER, AIR POLISHER
MATERIALS: ENGINEERED STONE, GRANITE

GRIT	4"	5"	FITTING	RPM/WET
50	PDRH450	PDRH550	Velcro back	4000
100	PDRH4100	PDRH5100	Velcro back	4000
200	PDRH4200	PDRH5200	Velcro back	4000
400	PDRH4400	PDRH5400	Velcro back	4000
800	PDRH4800	PDRH5800	Velcro back	4000
1500	PDRH41500	PDRH51500	Velcro back	4000
3000	PDRH43000	PDRH53000	Velcro back	4000

CYCLONE POLISHING CONVEX DISK



Pads are useful for ogee edge polishing

Good for polishing difficult to reach areas like inside corners of sink cut outs

Velcro backed for use with 3" backer pad

TOOLS: ANGLE GRINDER, AIR POLISHER
MATERIALS: ENGINEERED STONE, GRANITE

GRIT	ITEM #	SIZE	FITTING	RPM/WET
50	PDCX30050	3"	Velcro back	2500
100	PDCX30100	3"	Velcro back	2500
200	PDCX30200	3"	Velcro back	2500
400	PDCX30400	3"	Velcro back	2500
800	PDCX30800	3"	Velcro back	2500
1500	PDCX31500	3"	Velcro back	2500
3000	PDCX33000	3"	Velcro back	2500
Black buff	PDCX3BB	3"	Velcro back	2500
White buff	PDCX3BW	3"	Velcro back	2500

CYCLONE MINI-POLISHING DRUM SLEEVE & ADAPTER



Small diameter allows you to wet polish tight radiuses not accessible with a pad

Dual threaded adapter allows for use on CNC or hand-held water fed polisher

Available in 7 grits that change out easily from the stainless steel adapter

Wet use only

TOOLS: ANGLE GRINDER, AIR POLISHER
MATERIALS: ENGINEERED STONE, GRANITE, MARBLE

GRIT	ITEM #	SIZE (W X L)	DUAL FITTING	RPM
50	SRD250	3/4" x 11/2"	1/2 gas & 5/8"-11	3000
100	SRD2100	3/4" x 11/2"	1/2 gas & 5/8"-11	3000
200	SRD2200	3/4" x 11/2"	1/2 gas & 5/8"-11	3000
400	SRD2400	3/4" x 11/2"	1/2 gas & 5/8"-11	3000
800	SRD2800	3/4" x 11/2"	1/2 gas & 5/8"-11	3000
1500	SRD21500	3/4" x 11/2"	1/2 gas & 5/8"-11	3000
3000	SRD23000	3/4" x 11/2"	1/2 gas & 5/8"-11	3000

ITEM #	SIZE	FITTING
SRDAPT	4" adapter length	5/8" Inner thread + 1/2" gas outer

CYCLONE POLISHING DRUM WHEEL



Edge polishing for sink cut-outs

Recommended use: Oscillate up and down for proper even drum wear

Rubber drum increases tread life & reduces vibration

TOOLS: ANGLE GRINDER, AIR POLISHER
MATERIALS: ENGINEERED STONE, GRANITE

GRIT	ITEM #	SIZE	FITTING	RPM/WET
50	RD250	2"x 1.5"	5/8"- 11	3000
100	RD2100	2"x 1.5"	5/8"- 11	3000
200	RD2200	2"x 1.5"	5/8"- 11	3000
400	RD2400	2"x 1.5"	5/8"- 11	3000
800	RD2800	2"x 1.5"	5/8"- 11	3000
1500	RD21500	2"x 2"	5/8"- 11	3000
3000	RD23000	2"x 2"	5/8"- 11	3000
Black buff	RD2BB	2"x 2"	5/8"- 11	3000
White buff	RD2BW	2"x 2"	5/8"- 11	3000

ENGINEERED STONE POLISHING



KEY FEATURES

Will not burn
engineered stone

Polish engineered
stone faster than
our competitors

Enhanced resin formula
guarantees to never bleed

Choose from our 7 step
or 3 step options



ENGINEERED STONE POLISHING

CYCLONE HYBRID 3 STEP WHITE POLISHING SYSTEM



New pattern for faster polish on Engineered Stone, Granite, and porcelain!

Reinforced outer rim to eliminate breakage

Textured face for faster break in time

Hybrid diamond matrix to polish all materials wet and dry

TOOLS: ANGLE GRINDER, AIR POLISHER

MATERIALS: ENGINEERED STONE, GRANITE, PORCELAIN, ULTRA-COMPACT

POS.	ITEM #	SIZE	DESCRIPTION	RPM
0	CHES400	4"	Velcro back, 3mm resin	4000
1	CHES401	4"	Velcro back, 3mm resin	4000
2	CHES402	4"	Velcro back, 3mm resin	4000
3	CHES403	4"	Velcro back, 3mm resin	4000

HURRICANE ES WHITE 3 STEP POLISHING SYSTEM



Provides all the great features of the Cyclone version at a more competitive price

Outperforms other industry brands at the same price point level

More forgiving when polishing engineered stone with minimal water

TOOLS: ANGLE GRINDER, AIR POLISHER

MATERIALS: ENGINEERED STONE, GRANITE

POS.	ITEM #	SIZE	DESCRIPTION	RPM
0	ESHWP400	4"	Velcro back, 3mm resin	4000
1	ESHWP401	4"	Velcro back, 3mm resin	4000
2	ESHWP402	4"	Velcro back, 3mm resin	4000
3	ESHWP403	4"	Velcro back, 3mm resin	4000
1	ESHWP501	5"	Velcro back, 3mm resin	4000
2	ESHWP502	5"	Velcro back, 3mm resin	4000
3	ESHWP503	5"	Velcro back, 3mm resin	4000



Position 0 available in 4"



Cyclone Hybrid 3 Step White Polishing System

ENGINEERED STONE POLISHING

CYCLONE ES WHITE 7 STEP POLISHING SYSTEM

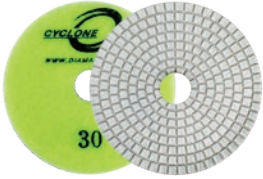

Small tread pattern for flexibility

Light colored resin to keep pads from bleeding into your engineered stone

TOOLS: ANGLE GRINDER, AIR POLISHER
MATERIALS: ENGINEERED STONE, GRANITE

GRIT	ITEM #	SIZE	DESCRIPTION	RPM
30	ESWP40030	4"	Velcro back, 3mm resin	4000
60	ESWP40060	4"	Velcro back, 3mm resin	4000
150	ESWP40150	4"	Velcro back, 3mm resin	4000
400	ESWP40400	4"	Velcro back, 3mm resin	4000
800	ESWP40800	4"	Velcro back, 3mm resin	4000
1500	ESWP41500	4"	Velcro back, 3mm resin	4000
3000	ESWP43000	4"	Velcro back, 3mm resin	4000

HURRICANE ES WHITE 7 STEP POLISHING SYSTEM

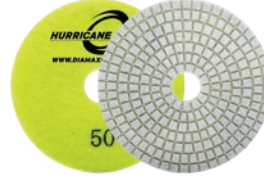

Outperforms other industry brands at the same price point level

For use on natural stone and engineered stone

TOOLS: ANGLE GRINDER, AIR POLISHER
MATERIALS: ENGINEERED STONE, GRANITE

GRIT	ITEM #	SIZE	DESCRIPTION	RPM
50	ESHWP40050	4"	Velcro back, 3mm resin	4000
100	ESHWP40100	4"	Velcro back, 3mm resin	4000
200	ESHWP40200	4"	Velcro back, 3mm resin	4000
400	ESHWP40400	4"	Velcro back, 3mm resin	4000
800	ESHWP40800	4"	Velcro back, 3mm resin	4000
1500	ESHWP41500	4"	Velcro back, 3mm resin	4000
3000	ESHWP43000	4"	Velcro back, 3mm resin	4000



ENGINEERED STONE POLISHING

TYPHOON ES WHITE 3 STEP POLISHING SYSTEM



New Clover tread design traps water for a high polish

Pads are highly flexibility with clover tread

Rounded pad edges eliminate any accidental scratches

TOOLS: ANGLE GRINDER, AIR POLISHER
MATERIALS: ENGINEERED STONE, GRANITE

STEP	ITEM #	SIZE	DESCRIPTION	RPM
#1	ESTWR401	4"	Velcro back, 3mm resin	4000
#2	ESTWR402	4"	Velcro back, 3mm resin	4000
#3	ESTWR403	4"	Velcro back, 3mm resin	4000

TYPHOON ES WHITE 7 STEP POLISHING SYSTEM

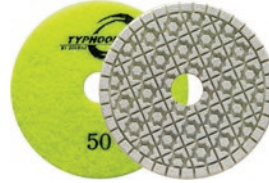

New Clover tread design traps water for a high polish

Pads are highly flexibility with clover tread

Rounded pad edges eliminate any accidental scratches

TOOLS: ANGLE GRINDER, AIR POLISHER
MATERIALS: ENGINEERED STONE, GRANITE

GRIT	ITEM #	SIZE	DESCRIPTION	RPM
50	EWR40050	4"	Velcro back, 3mm resin	4000
100	EWR40100	4"	Velcro back, 3mm resin	4000
200	EWR40200	4"	Velcro back, 3mm resin	4000
400	EWR40400	4"	Velcro back, 3mm resin	4000
800	EWR40800	4"	Velcro back, 3mm resin	4000
1500	EWR41500	4"	Velcro back, 3mm resin	4000
3000	EWR43000	4"	Velcro back, 3mm resin	4000



DRY POLISHING



KEY FEATURES

First to introduce
dry polishing pads
to North America

3, 5, and 8 step
systems available

Dry polishing systems
at all price points

Extremely flexible



DRY POLISHING



CYCLONE ULTRA WET / DRY POLISHING

Maximum diamond concentration content allows these pads to polish ultra compact and porcelain tile edges very efficiently

Great flexibility for tight radius work

Light colored resin minimizes bleeding

Wet or dry use

TOOLS: ANGLE GRINDER, AIR POLISHER
MATERIALS: GRANITE, MARBLE, PORCELAIN/TILE, ULTRA-COMPACT, QUARTZ

ITEM #	SIZE	GRIT	PAD/BOND	WET	DRY
PDU40050	4"	50	2mm, Resin	4000	3000
PDU40100	4"	100	2mm, Resin	4000	3000
PDU40200	4"	200	2mm, Resin	4000	3000
PDU40400	4"	400	2mm, Resin	4000	3000
PDU40800	4"	800	2mm, Resin	4000	3000
PDU41500	4"	1500	2mm, Resin	4000	3000
PDU43000	4"	3000	2mm, Resin	4000	3000

MAX RPM

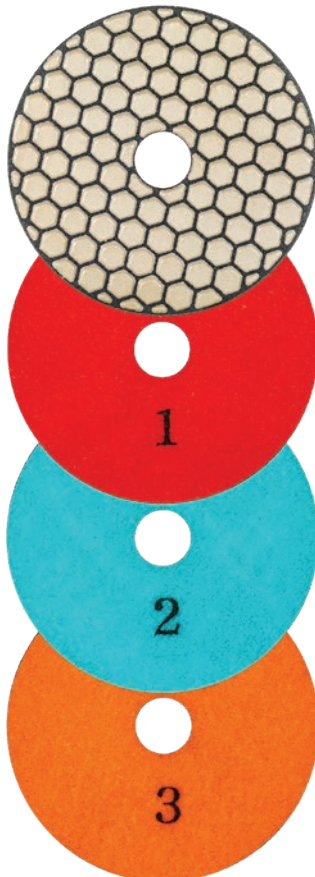

NEW

DRYFLEX III

Super High gloss in just 3 steps!!!

Use wet and dry

Use Dryflex 4000 or 5000 on dark material

TOOLS: ANGLE GRINDER, AIR POLISHER
MATERIALS: GRANITE

POS	ITEM #	SIZE	FITTING	RPM
1	PDH301	4"	Velcro back	3000
2	PDH302	4"	Velcro back	3000
3	PDH303	4"	Velcro back	3000

DRY POLISHING

DRYFLEX DRY POLISHING SYSTEM

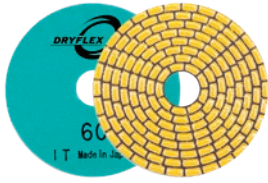

Designed for craftsmen who really take pride in their work and tools

4000 & 5000 grits with a trickle of water are the best final buffs in the business

Excellent set of pads to have at the job site for quick touch-ups

Gains flexibility after continual use

TOOLS: ANGLE GRINDER, AIR POLISHER
MATERIALS: GRANITE

GRIT	ITEM #	SIZE	FITTING	BOND	RPM
60	PDH460B	4"	Velcro back	Ceramic	3000
100	PDH4100B	4"	Velcro back	Ceramic	3000
200	PDH4200B	4"	Velcro back	Ceramic	3000
400	PDH4400B	4"	Velcro back	Ceramic	3000
800	PDH4800B	4"	Velcro back	Ceramic	3000
1500	PDH41500B	4"	Velcro back	Ceramic	3000
3000	PDH43000B	4"	Velcro back	Ceramic	3000
4000	PDH44000B	4"	Velcro back	Ceramic	3000
5,000	PDH45000B	4"	Velcro back	Ceramic	3000

DRYFLEX II DRY POLISHING SYSTEM

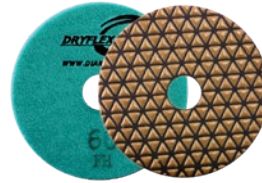

Same professional finish as Dryflex at a more affordable cost

4000 & 5000 grits used with a trickle of water make for excellent final buffs

Must have for every tool box

TOOLS: ANGLE GRINDER, AIR POLISHER
MATERIALS: GRANITE

GRIT	ITEM #	SIZE	FITTING	BOND	RPM
60	PDH460E	4"	Velcro back	Ceramic	3000
100	PDH4100E	4"	Velcro back	Ceramic	3000
200	PDH4200E	4"	Velcro back	Ceramic	3000
400	PDH4400E	4"	Velcro back	Ceramic	3000
800	PDH4800E	4"	Velcro back	Ceramic	3000
1500	PDH41500E	4"	Velcro back	Ceramic	3000
3000	PDH43000E	4"	Velcro back	Ceramic	3000
4000	PDH44000E	4"	Velcro back	Ceramic	3000
5,000	PDH45000E	4"	Velcro back	Ceramic	3000

DRYFLEX 5 POLISHING SYSTEM



Super high gloss finish in 5 steps or less

Achieves highest gloss meter reading of all our dry pad systems

Polish lighter stone materials w/ 4 steps

Best system to polish engineered stone (ES). Test first on ES. Some ES may turn black.

TOOLS: ANGLE GRINDER, AIR POLISHER
MATERIALS: GRANITE

POS.	ITEM #	SIZE	FITTING	MAX RPM
#1	PDH51	4"	Velcro back	4000
#2	PDH52	4"	Velcro back	4000
#3	PDH53	4"	Velcro back	4000
#4	PDH54	4"	Velcro back	4000
#5	PDH55	4"	Velcro back	4000

DIAFLEX DRY POLISHING SYSTEM

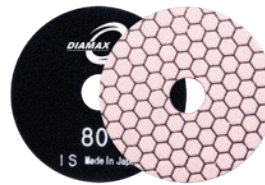

The first dry polishing system introduced into North America

Still the best dry pad system in the world

Nothing lasts longer or delivers the polish of DIAFLEX

This system allows you to put a great polished shine on difficult stones with its unique 6000 & 8000 grits

TOOLS: ANGLE GRINDER, AIR POLISHER
MATERIALS: GRANITE

GRIT	ITEM #	SIZE	FITTING	BOND	RPM
60	PDH40060	4"	Velcro back	Ceramic	4000
80	PDH40080	4"	Velcro back	Ceramic	4000
200	PDH40200	4"	Velcro back	Ceramic	4000
400	PDH40400	4"	Velcro back	Ceramic	4000
800	PDH40800	4"	Velcro back	Ceramic	4000
1500	PDH41500	4"	Velcro back	Ceramic	4000
3000	PDH43000	4"	Velcro back	Ceramic	4000
6,000	PDH46000	4"	Velcro back	Ceramic	4000
8,000	PDH48000	4"	Velcro back	Ceramic	4000

DRY POLISHING

CYCLONE DRY POLISHING SYSTEM

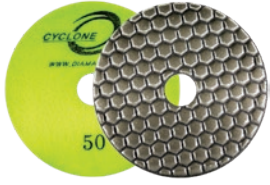

Best selling dry polishing disk in our line

Thinner velcro offers more flexibility for polishing complex edges

Great for polishing engineered stone wet

TOOLS: ANGLE GRINDER, AIR POLISHER
MATERIALS: GRANITE

GRIT	ITEM #	SIZE	FITTING	RPM
50	CDP450	4"	Velcro back	3000
100	CDP4100	4"	Velcro back	3000
200	CDP4200	4"	Velcro back	3000
400	CDP4400	4"	Velcro back	3000
800	CDP4800	4"	Velcro back	3000
1500	CDP41500	4"	Velcro back	3000
3000	CDP43000	4"	Velcro back	3000
Black buff	CDP4BB	4"	Velcro back	3000
White buff	CDP4BW	4"	Velcro back	3000

HURRICANE DRY POLISHING SYSTEM

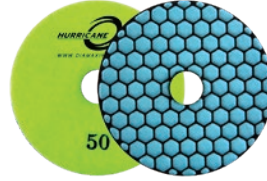

Specially formulated adhesive keeps the pad together even under high heat

Use dry or wet

TOOLS: ANGLE GRINDER, AIR POLISHER
MATERIALS: GRANITE

GRIT	ITEM #	SIZE	FITTING	RPM
50	HDP450	4"	Velcro back	3000
100	HDP4100	4"	Velcro back	3000
200	HDP4200	4"	Velcro back	3000
400	HDP4400	4"	Velcro back	3000
800	HDP4800	4"	Velcro back	3000
1500	HDP41500	4"	Velcro back	3000
3000	HDP43000	4"	Velcro back	3000
Black buff	HDP4BB	4"	Velcro back	3000
White buff	HDP45000	4"	Velcro back	3000

TYPHOON DRY POLISHING SYSTEM

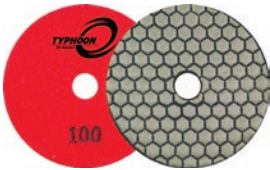

The best dry polishing system in its class

When cost is an issue nothing gives you more utility and shine than Typhoon

TOOLS: ANGLE GRINDER, AIR POLISHER
MATERIALS: GRANITE

GRIT	ITEM #	SIZE	FITTING	RPM
50	TDP40050	4"	Velcro back	4000
100	TDP40100	4"	Velcro back	4000
200	TDP40200	4"	Velcro back	4000
400	TDP40400	4"	Velcro back	4000
800	TDP40800	4"	Velcro back	4000
1500	TDP41500	4"	Velcro back	4000
3000	TDP43000	4"	Velcro back	4000



CORE DRILL BITS



KEY FEATURES

Cyclone, the #1 core drill brand in America

Segments can be used through to the end

Our non coring bits are the fastest around

Made to drill wet or dry



CORE DRILL BITS

CYCLONE DRY CORE BIT WITH INSIDE/OUTSIDE PROTECTION



Inside vacuum brazed diamonds assist with smooth drilling and easy core removal

Comes with outside vacuum brazed side protection

Perfect for use in the field when water is not an option. Can be used dry or wet.

Use water to prolong segment life

5/8" - 11 female thread

TOOLS: ANGLE GRINDER, PNEUMATIC MACHINE, DRILL, AIR POLISHER

MATERIALS: ENGINEERED STONE, GRANITE

ITEM #	SIZE	USABLE LENGTH	RPM HAND GRINDER	RPM DRILL PRESS,CNC
			STONE HARD / SOFT	STONE HARD / SOFT
CDBYTSD100	1"	3"	3200 / 6500	2000 / 3200
CDBYTSD114	1 1/4"	3"	4800 / 6500	2000 / 3200
CDBYTSD138	1 3/8"	3"	4800 / 6500	2000 / 3200
CDBYTSD112	1 1/2"	3"	4800 / 6500	2000 / 3200
CDBYTSD158	1 5/8"	3"	4800 / 6500	2000 / 3200
CDBYTSD134	1 3/4"	3"	4500 / 5300	2200 / 2700
CDBYTSD200	2"	3"	4500 / 5300	2200 / 2700

CYCLONE TURBO DRY CORE BIT WITH SIDE DIAMONDS



Aggressive turbo rim designed for increased speed

T-segment design minimizes segment loss

Hefty vacuum brazed side protection

For wet or dry use

5/8" - 11 female thread

TOOLS: ANGLE GRINDER, PNEUMATIC MACHINE, DRILL, AIR POLISHER

MATERIALS: ENGINEERED STONE, GRANITE

ITEM #	SIZE	USABLE LENGTH	RPM HAND GRINDER	RPM DRILL PRESS,CNC
			STONE HARD / SOFT	STONE HARD / SOFT
CDBYTU114	1 1/4"	3"	4800 / 6500	2000 / 3200
CDBYTU138	1 3/8"	3"	4800 / 6500	2000 / 3200

CYCLONE S THIN WALL CORE BIT



Designed for long lifespan, fast coring speeds and clean cuts

Wet use only

TOOLS: ANGLE GRINDER, PNEUMATIC MACHINE, DRILL, AIR POLISHER

MATERIALS: ENGINEERED STONE, GRANITE, PORCELAIN/TILE, ULTRA-COMPACT

ITEM #	SIZE	FITTING	USABLE LENGTH	MAX RPM
CDBCTW114	1 1/4"	5/8" - 11 thread	2 1/2"	1250
CDBCTW138	1 3/8"	5/8" - 11 thread	2 1/2"	1250
CDBCTW112	1 1/2"	5/8" - 11 thread	2 1/2"	1250

CYCLONE VACUUM BRAZED CORE BIT



Cores through the softest marble clean & chip free

Vacuum brazed diamonds on inside and outside of core

Cooling slots allows for easier core removal when stuck

Performs wet or dry

TOOLS: ANGLE GRINDER, PNEUMATIC MACHINE, DRILL, AIR POLISHER

MATERIALS: MARBLE, PORCELAIN/TILE, ULTRA-COMPACT

ITEM #	SIZE	FITTING	USABLE LENGTH	MAX RPM
CDBM114	1 1/4"	5/8" - 11 thread	2.75"	4000
CDBM138	1 3/8"	5/8" - 11 thread	2.75"	4000
CDBM112	1 1/2"	5/8" - 11 thread	2.75"	4000



CYCLONE S QZT CORE BIT

CYCLONE S QZT CORE BIT WITH INSIDE/OUTSIDE PROTECTION

Bond formulated to cut through hard quartzite fast. Also, assures a long lifespan.

Works on granite, engineered stone and marble

Brazed diamonds on the inside and outside core

Inlaid T-segments

Works wet or dry



NEW SIZES

TOOLS: ANGLE GRINDER, PNEUMATIC MACHINE, DRILL, AIR POLISHER
MATERIALS: ENGINEERED STONE, GRANITE, QUARTZITE

AVAILABLE SIZES

ITEM #	SIZE
CDBQZ316	3/16"
CDBQZ014	1/4"
CDBQZ516	5/16"
CDBQZ038	3/8"
CDBQZ012	1/2"
CDBQZ058	5/8"
CDBQZ034	3/4"
CDBQZ100	1"
CDBQZ114	1 1/4"
CDBQZ138	1 3/8"
CDBQZ112	1 1/2"
CDBQZ158	1 5/8"
CDBQZ134	1 3/4"
CDBQZ200	2"
CDBQZ212	2.5"
CDBQZ300	3"

FITTING
5/8"- 11 thread

USABLE LENGTH
3"

MAX RPM
6500

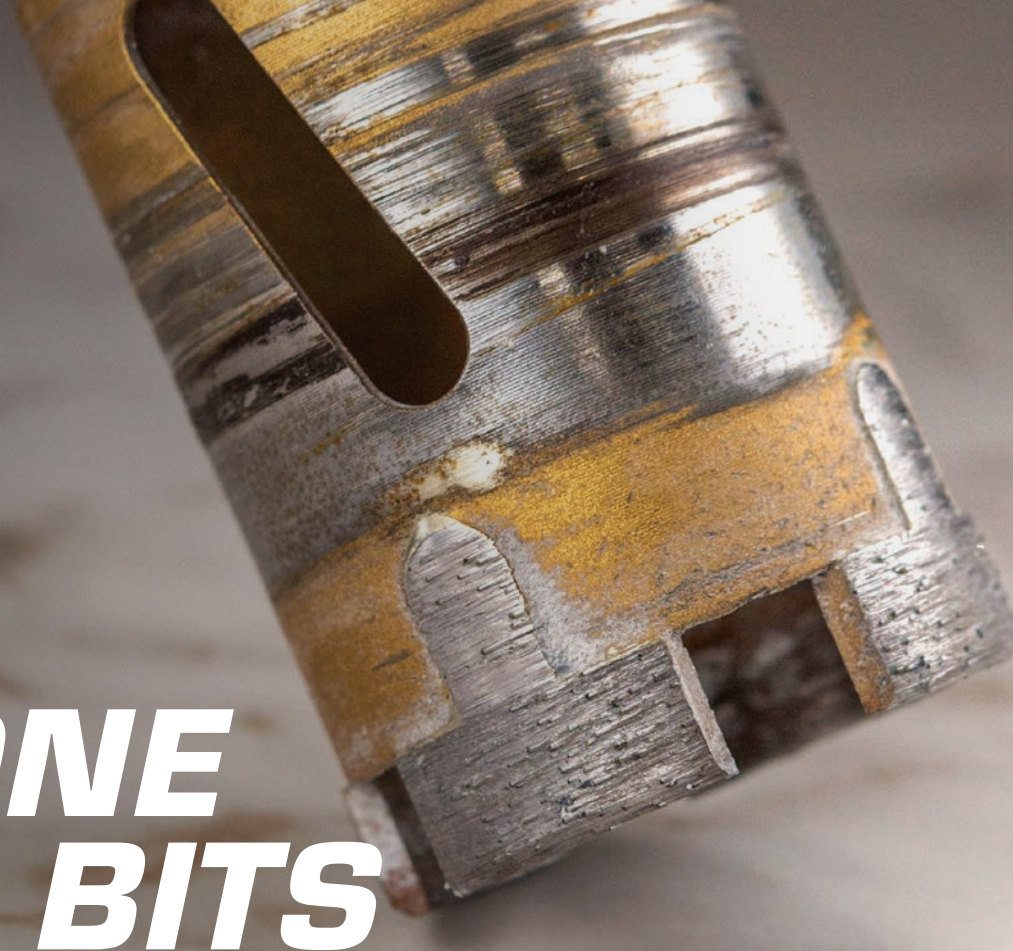

CYCLONE ULTRA BITS

CYCLONE ULTRA CORE BIT

Specific metal bond and diamond composition provides a fast clean hole in porcelain and ultra compact material

Thin tapered segments give clean cuts

Wet or dry use



NEW SIZES

TOOLS: ANGLE GRINDER, PNEUMATIC MACHINE, DRILL, AIR POLISHER

MATERIALS: ENGINEERED STONE, GRANITE, MARBLE, PORCELAIN/TILE, QUARTZITE, ULTRA-COMPACT

AVAILABLE SIZES	
ITEM #	SIZE
CUDB100	1"
CUDB114	1 1/4"
CUDB138	1 3/8"
CUDB112	1 1/2"
CUDB134	1 3/4"
CUDB200	2"
CUDB214	2 1/4"
CUDB212	2 1/2"
CUDB300	3"
CUDB312	3 1/2"
CUDB400	4"

FITTING
5/8" - 11

USABLE LENGTH
2.25"

MAX RPM
5000

CYCLONE ULTRA NON CORE BIT

Designed with a special bond for large format porcelain and ultra compact material

Wet or dry use



NEW SIZES

TOOLS: ANGLE GRINDER, PNEUMATIC MACHINE, DRILL, AIR POLISHER

MATERIALS: GRANITE, MARBLE, PORCELAIN/TILE, ULTRA-COMPACT

AVAILABLE SIZES		
ITEM #	SIZE	USABLE LENGTH
CUDB014	1/4"	2"
CUDB516	5/16"	2"
CUDB038	3/8"	2.75"
CUDB012	1/2"	2.75"
CUDB058	5/8"	2.75"
CUDB034	3/4"	2.75"

BOND
Medium

FITTING
5/8"- 11

MAX RPM
5000

CORE DRILL BITS

CYCLONE DRY NON-CORING BIT



New dry segment matrix allows these non-core drill bits to perform under high heat conditions

For best performance use at 6500 RPM with center-fed water

Use dry or wet

TOOLS: ANGLE GRINDER, PNEUMATIC MACHINE, DRILL, AIR POLISHER

MATERIALS: ENGINEERED STONE, GRANITE, MARBLE

ITEM #	SIZE	FITTING	USABLE LENGTH	RPM
CDBYNC316	3/16"	5/8" - 11 thread	2"	6500
CDBYNC516	5/16"	5/8" - 11 thread	2"	6500
CDBYNC14	1/4"	5/8" - 11 thread	2"	6500
CDBYNC38	3/8"	5/8" - 11 thread	2.75"	6500
CDBY12	1/2"	5/8" - 11 thread	2.75"	6500
CDBY58	5/8"	5/8" - 11 thread	2.75"	6500
CDBY34	3/4"	5/8" - 11 thread	2.75"	6500

CYCLONE DRY/WET CORE BIT



Our fastest core bit will drill most granite in under 30 seconds with water

Largest inventory available from 1" to 6"

A better alternative to thin wall core bits

Vacuum-brazed side-protection

Use dry or wet

TOOLS: ANGLE GRINDER, PNEUMATIC MACHINE, DRILL, AIR POLISHER

MATERIALS: ENGINEERED STONE, GRANITE, PORCELAIN/TILE, ULTRA-COMPACT

ITEM #	SIZE	FITTING	USABLE LENGTH	RPM
CDBS100	1"	5/8" - 11 thread	3"	6500
CDBS118	1 1/8"	5/8" - 11 thread	3"	6500
CDBS114	1 1/4"	5/8" - 11 thread	3"	6500
CDBS138	1 3/8"	5/8" - 11 thread	3"	6500
CDBS112	1 1/2"	5/8" - 11 thread	3"	6500
CDBS158	1 5/8"	5/8" - 11 thread	3"	5300
CDBS134	1 3/4"	5/8" - 11 thread	3"	5300
CDBS200	2"	5/8" - 11 thread	3"	4200
CDBS214	2 1/4"	5/8" - 11 thread	3"	4200
CDBS238	2 3/8"	5/8" - 11 thread	3"	4200
CDBS212	2 1/2"	5/8" - 11 thread	3"	3600
CDBS234	2 3/4"	5/8" - 11 thread	3"	3600
CDBS300	3"	5/8" - 11 thread	3"	3000
CDBS312	3 1/2"	5/8" - 11 thread	3"	2700
CDBS400	4"	5/8" - 11 thread	3"	2100
CDBS412	4 1/2"	5/8" - 11 thread	3"	2000
CDBS500	5"	5/8" - 11 thread	3"	1800
CDBS512	5 1/2"	5/8" - 11 thread	3"	1600
CDBS600	6"	5/8" - 11 thread	3"	1400

CORE DRILL BITS

HURRICANE DRY CORE BIT



High performing dry core drill bit in an economy package

New design with outside vacuum brazed side protection and mini-T segment for better durability

TOOLS: ANGLE GRINDER, PNEUMATIC MACHINE, DRILL, AIR POLISHER

MATERIALS: ENGINEERED STONE, GRANITE

ITEM #	SIZE	FITTING	USABLE LENGTH	MAX RPM
CDBYHD114	1 1/4"	5/8" - 11 thread	3"	6500
CDBYHD138	1 3/8"	5/8" - 11 thread	3"	6500
CDBYHD112	1 1/2"	5/8" - 11 thread	3"	6500

TYPHOON DRY CORE BIT



Thin wall cylinder makes this core bit fast & economical

Comes with vacuum brazed diamonds on the outside core

Special grit formulation for dense material

Turbo rim cuts the hardest materials

TOOLS: ANGLE GRINDER, PNEUMATIC MACHINE, DRILL, AIR POLISHER

MATERIALS: ENGINEERED STONE, GRANITE, QUARTZITE

ITEM #	SIZE	FITTING	USABLE LENGTH	MAX RPM
CDBTD114	1 1/4"	5/8" - 11 thread	3"	6500
CDBTD138	1 3/8"	5/8" - 11 thread	3"	6500
CDBTD112	1 1/2"	5/8" - 11 thread	3"	6500

SUGGESTED RPM FOR SEGMENTED / SINTERED CORE BITS

SIZE	RPM HAND GRINDER	RPM DRILL PRESS, CNC
	STONE HARD / SOFT	STONE HARD / SOFT
3/16"	3200 - 6500	2000 - 2500
1/4"	3200 - 6500	2000 - 2500
5/16"	3200 - 6500	2000 - 2500
3/8"	3200 - 6500	2000 - 2500
1/2"	3200 - 6500	2000 - 2500
5/8"	3200 - 6500	2000 - 2500
3/4"	3200 - 6500	2000 - 3200
1"	3200 - 6500	2000 - 3200
1 1/8"	4800 - 6500	2000 - 3200
1 1/4"	4800 - 6500	2000 - 3200
1 3/8"	4800 - 6500	2000 - 3200
1 1/2"	4800 - 6500	2000 - 3200
1 5/8"	4800 - 6500	2000 - 3200
1 3/4"	4500 - 5300	2200 - 2700
2"	4500 - 5300	2200 - 2700
2 1/4"	3700 - 4200	1800 - 2100
2 3/8"	3700 - 4200	1800 - 2100
2 1/2"	3700 - 4200	1800 - 2100
2 3/4"	3000 - 3600	1600 - 1800
3"	2700 - 3000	1400 - 1600
3 1/2"	2400 - 2700	1200 - 1400
4"	2100 - 2400	1100 - 1200
4 1/2"	1800 - 2000	900 - 1000
5"	1700 - 1800	800 - 900
6"	1300 - 1400	700

Not applicable for vacuum brazed core bits (CDBM)

ULTRA-COMPACT HIGHLIGHTS



PG 04

**SUPER CYCLONE
PORCELAIN BLADE**



PG 02

**CYCLONE
ULTRA BLADE**



PG 64

**CYCLONE ULTRA MESH
TURBO BLADE**



PG 22

**CYCLONE ULTRA WET /
DRY POLISHING**



PG 40

**SUPER CYCLONE
MULTI CUTTER**



PG 41

**CYCLONE ULTRA
CUP WHEEL**



PG 28

CYCLONE ULTRA BIT



PG 52

**CYCLONE ULTRA CNC
CORE BIT**



PG 53

**CYCLONE ULTRA CNC
FINGER BIT**



PG 56

**CYCLONE ULTRA
INCREMENTAL BIT**

DEKTON APPROVED PRODUCTS



PG 02

**CYCLONE
ULTRA BLADE**



PG 64

**CYCLONE ULTRA MESH
TURBO BLADE**



PG 41

**CYCLONE ULTRA
CUP WHEEL**



PG 56

**CYCLONE ULTRA
INCREMENTAL BIT**



PG 26

**CYCLONE S THIN
WALL CORE BIT**



PG 52

**CYCLONE S CNC
CORE BIT**





CYCLONE PNEUMATIC AIR GRINDER

6" guard with an integrated water feed for cutting with shut off valve

Easy to use push connect air and water connections

60 day warranty

Internal water feed for coring and grinding

10000 RPMs





CYCLONE PNEUMATIC AIR GRINDER

ITEM # MVG60 **RPM** 10000 **AIR PRESSURE / CONSUMPTION** 16 CFM @ 90 PSI **FITTING** 6" Guard

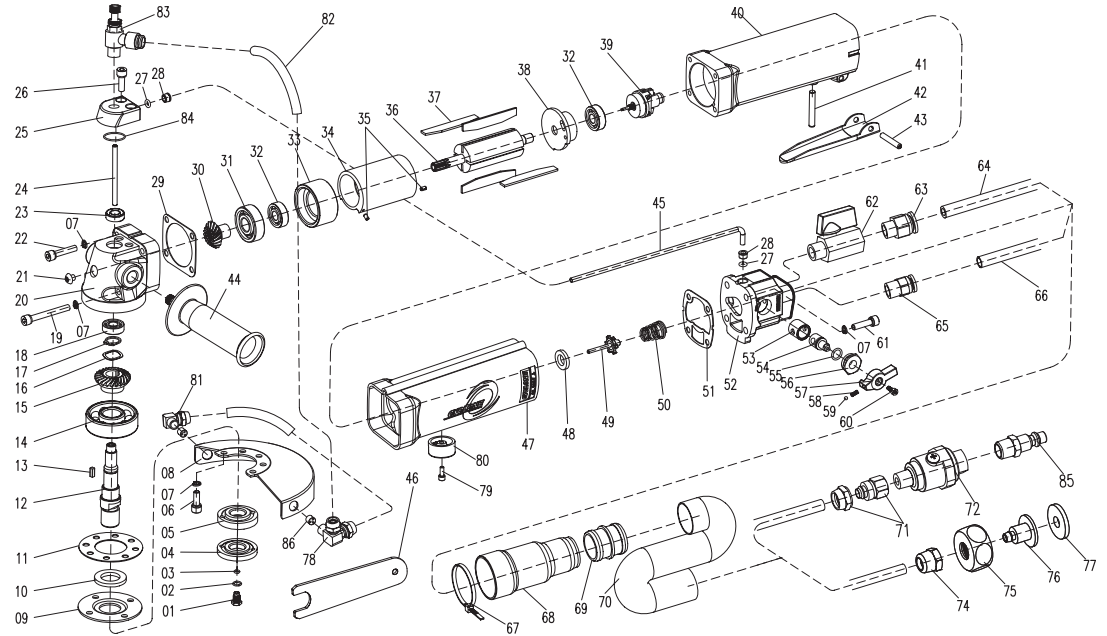

PARTS #	DESCRIPTION	QTY	PARTS #	DESCRIPTION	QTY	PARTS #	DESCRIPTION	QTY	PARTS #	DESCRIPTION	QTY
MVGAC01	Nozzle	1	MVGAC24	Inner pipe	1	MVGAC45	Water pipe	1	MVGAC68	Exhaust cover	1
MVGAC02	O-Ring [01.5x7]	1	MVGAC25	Pipe-joint assembly	1	MVGAC46	Wrench	1	MVGAC69	Connector	1
MVGAC03	O-Ring (02x3)	1	MVGAC26	Screw (M5X16)	2	MVGAC47	Body cover	1	MVGAC70	Exhaust hose	1
MVGAC04	The outer plate	1	MVGAC27	O-Ring (01.9X3.4)	2	MVGAC48	Valve seat	1	MVGAC71	Fast twist joint (PCF12-02)	1
MVGAC05	The inner plate	1	MVGAC28	Pipe bush	2	MVGAC49	Valve	1	MVGAC72	Oil spray	1
MVGAC06	Screw (M5X12)	4	MVGAC29	Gasket	1	MVGAC50	Valve spring	1	MVGAC74	Nut	1
MVGAC07	Washer	12	MVGAC30	Spiral bevel pinion (16T)	1	MVGAC51	Gasket	1	MVGAC75	Nut	1
MVGAC08	Disc Cover	1	MVGAC31	Bearing	1	MVGAC52	End case	1	MVGAC76	Connector	1
MVGAC09	Retainer	1	MVGAC32	Bearing	2	MVGAC53	Valve bush	1	MVGAC77	Bushing	1
MVGAC10	Felt Seal	1	MVGAC33	Front bearing case	1	MVGAC54	Water valve	1	MVGAC78	Tee joint	1
MVGAC11	Gasket	1	MVGAC34	Cylinder	1	MVGAC55	O-Ring (01.5X8)	1	MVGAC79	Screw (M4x12)	1
MVGAC12	Gear shaft (5/8-11)	1	MVGAC35	Spring pin (0.25X5)	2	MVGAC56	Nut	1	MVGAC80	Exhaust knob	1
MVGAC13	Key	1	MVGAC36	Rotor	1	MVGAC57	Valve lever	1	MVGAC81	Joint KLL8-01	1
MVGAC14	Bearing	1	MVGAC37	Vane	4	MVGAC58	Spring	1	MVGAC82	Water hose	2
MVGAC15	Bevel gear (23T)	1	MVGAC38	Rear bearing case	1	MVGAC59	Ball bearing (03)	1	MVGAC83	Throttle valve	1
MVGAC16	Wave washer (012)	1	MVGAC39	Governor	1	MVGAC60	Screw (M3x8)	1	MVGAC84	O-Ring (01.0x14)	1
MVGAC17	Snap ring (012)	1	MVGAC40	Motor housing	1	MVGAC61	Screw (M5x20)	4	MVGAC85	Quick coupling	1
MVGAC18	Bearing	1	MVGAC41	Valve pin (05x35)	1	MVGAC62	Ball valve	1	MVGAC86	Plug	2
MVGAC19	Screw (M5X50)	2	MVGAC42	Throttle lever	1	MVGAC63	Hose joint (PC12-2)	1			
MVGAC20	Angle head	1	MVGAC43	Roll pin (04X22)	1	MVGAC64	Air pipe	1			
MVGAC21	Screw (M6x5)	1	MVGAC44	Grip	1	MVGAC65	Hose joint (PC8-01)	1			
MVGAC22	Screw (M5x25)	2				MVGAC66	Water hose	1			
MVGAC23	Oil seal (TC8X15X5)	1				MVGAC67	Clamp	1			



CYCLONE MVP PNEUMATIC AIR POLISHER

First air polisher
to be completely
assembled by hand

Will not lose power
even when pushing
hard on stone

60 day warranty from
date of purchase

Push connects
included in the box

Recommended RPM
4500, Max RPM 5500



CYCLONE MVP PNEUMATIC AIR POLISHER

ITEM # MVP45 **RPM** 10000 **AIR PRESSURE / CONSUMPTION** 16 CFM (0.45m³/min) @ 90 PSI **FITTING** 5"

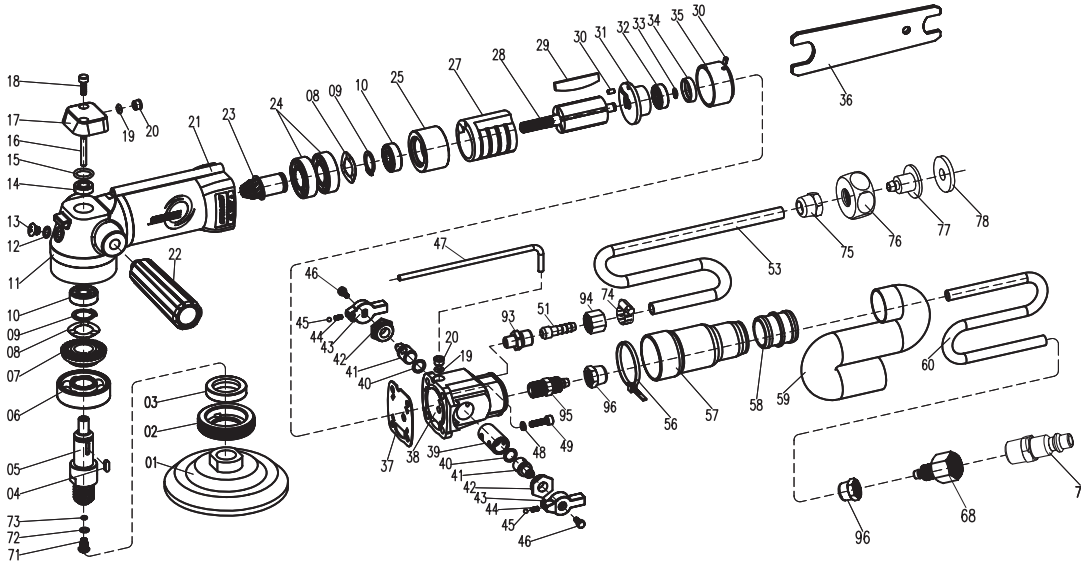

ITEM #	DESCRIPTION	QTY	ITEM #	DESCRIPTION	QTY	ITEM #	DESCRIPTION	QTY	ITEM #	DESCRIPTION	QTY
BPC40	Backing pad	1	MVPACC19	O-ring	2	MVPACC38	End case	1	MVPACC60	Air pipe	2.5
MVPACC02	Tighten nut	1	MVPACC20	Pipe bush	2	MVPACC39	Valve bush	1	MVPACC68	Air inlet connector	1
MVPACC03	Oil seal	1	MVPACC21	Body cover	1	MVPACC40	O-Ring	2	MVPACC70	Quick coupling	1
MVPACC04	Key	1	MVPACC22	Grip	1	MVPACC41	Air valve	2	MVPACC71	Nozzle	1
MVPACC05	Gear shaft	1	MVPACC23	Spiral bevel pinion	1	MVPACC42	Nut	2	MVPACC72	O-Ring	1
MVPACC06	Bearing	1	MVPACC24	Bearing	2	MVPACC43	Valve lever	2	MVPACC73	O-Ring	1
MVPACC07	Bevel gear	1	MVPACC25	Front bearing case	1	MVPACC44	Spring	2	MVPACC74	Pipe hoop	1
MVPACC08	Wave washer	2	MVPACC27	Cylinder	1	MVPACC45	Ball bearing	2	MVPACC75	Nut	1
MVPACC09	Snap ring	2	MVPACC28	Rotor	1	MVPACC46	Screw (M3x8)	2	MVPACC76	Nut	1
MVPACC10	Bearing	2	MVPACC29	Vane	5	MVPACC47	Water pipe	1	MVPACC77	Connector	1
MVPACC11	Motor housing	1	MVPACC30	Spring pin	2	MVPACC48	Washer	4	MVPACC78	Bushing	1
MVPACC12	O-ring	2	MVPACC31	Rear bearing case	1	MVPACC49	Screw (M4x16)	4	MVPACC93	Water Hose Joint	1
MVPACC13	Screw (M6x5)	2	MVPACC32	Bearing	1	MVPACC51	Water hose nipple	1	MVPACC94	Nut	1
MVPACC14	Oil seal	1	MVPACC33	Retaining ring	1	MVPACC53	Water hose	1	MVPACC95	Air-Hose Joint	1
MVPACC15	O-Ring	1	MVPACC34	Bearing cap	1	MVPACC56	Clamp	1	MVPACC96	Nut	2
MVPACC16	Inner pipe	1	MVPACC35	Air inlet case	1	MVPACC57	Exhaust cover	1			
MVPACC17	Pipe-joint assembly	1	MVPACC36	Wrench	1	MVPACC58	Connector	1			
MVPACC18	Screw (M4x12)	2	MVPACC37	Body packing	1	MVPACC59	Exhaust hose	1			



HURRICANE AIR POLISHER

Side exhaust - Specially designed to be 20% lighter than a rear exhaust, the Hurricane Air Polisher is ready for your toughest polishing projects.

ITEM #	RPM	AIR PRESSURE / CONSUMPTION	MAX PAD DIAMETER
HAP45	4500	16 CFM @ 90 PSI	5"





ROCKBUSTER

Eliminate dust...
with the RockBuster
resin cup wheel!

Diamax created a tool
that can get rid of silicon
carbide grinding wheels

NEW radius edge
designed to replicate the
most common shape

10mm radius allows usage
for tight sink radius work

New rubber body
eliminates vibration



GRINDERS/ SHAPERS



KEY FEATURES

Perfect balance and zero vibration comes standard

All router shapes in stock for immediate delivery

Zero tolerance wheels available with or without resin



GRINDERS/SHAPERS

SUPER CYCLONE MULTI CUTTER



NEW SIZES

Versatile shaping blade for trimming and grinding porcelain and softer, fragile materials

Makes fast, clean and aggressive cuts like a sharp blade

Safer grinding alternative to regular sintered tile blades

Will not break under pressure

Flush mount adapter included

Cuts clean miters

TOOLS: ANGLE GRINDER, AIR POLISHER

MATERIALS: MARBLE, PORCELAIN/TILE, ULTRA-COMPACT

ITEM #	SIZE	GRIT	FITTING	MAX RPM
EMC35	3.5"	Medium 50/60	5/8" - 11 thread	15000
EMC50	5"	Medium 50/60	5/8" - 11 thread	15000
EMC60	6"	Medium 50/60	5/8" - 11 thread	15000

CYCLONE S RESIN CUP WHEEL



30/50 grit are aggressive enough for rapid stock removal with minimal effort

100/200 grit work great for clean up on seams or miters. They also perform very well on ultra compact materials.

These wheels have the look and feel of a pad but have the performance and durability of a cup wheel

Aluminum body makes this cup wheel light

Use wet or dry

TOOLS: ANGLE GRINDER, AIR POLISHER

MATERIALS: CONCRETE, ENGINEERED STONE, GRANITE, MARBLE, ULTRA-COMPACT

ITEM #	SIZE	GRIT	ALUMINUM BACKER	BOND	WET MAX RPM	DRY MAX RPM
PDCS4030	4"	30	5/8" - 11	Hard	7000	4000 - 5000
PDCS4050	4"	50	5/8" - 11	Hard	7000	4000 - 5000
PDCS4100	4"	100	5/8" - 11	Hard	7000	4000 - 5000
PDCS4200	4"	200	5/8" - 11	Hard	7000	4000 - 5000

ROCKBUSTER

Gets rid of silicon carbide grinding wheels

New radius edge designed to replicate the most common shape

New rubber body eliminates vibration

30/50 grit are aggressive enough for rapid stock removal with minimal effort

100/200 grit work great for clean up on seams or miters and perform very well on ultra-compact materials

TOOLS: ANGLE GRINDER, AIR POLISHER

MATERIALS: CONCRETE, ENGINEERED STONE, GRANITE, MARBLE, ULTRA-COMPACT

ITEM #	SIZE	GRIT	FITTING BODY	RPM
PDRX4030	4"	30	5/8" - 11 thread, rubber	5000
PDRX4050	4"	50	5/8" - 11 thread, rubber	5000
PDRX4100	4"	100	5/8" - 11 thread, rubber	5000
PDRX4200	4"	200	5/8" - 11 thread, rubber	5000



GRINDERS/SHAPERS

CYCLONE HEX FLAT RESIN CUP WHEEL



Resin surface gives a smooth feel when grinding

More aggressive than the Cyclone Flat Resin Cup Wheel

Flat 90° surface allows for corner shaping and grinding

Aluminum body makes this cup wheel light

Wet or dry use

TOOLS: ANGLE GRINDER, AIR POLISHER

MATERIALS: ENGINEERED STONE, GRANITE, ULTRA-COMPACT, QUARTZITE

ITEM #	SIZE	GRIT	FITTING	MAX RPM
CFRCW40	4"	Coarse 30	5/8"- 11 thread	3500 - 4000
CFRCW4M	4"	Medium 50/60	5/8"- 11 thread	3500 - 4000
CFRCW4F	4"	Fine 80/100	5/8"- 11 thread	3500 - 4000

CYCLONE ULTRA CUP WHEEL



Fine diamond grit allows a chip-free grind on porcelain, marble and troublesome granite

Fiber backing absorbs vibration to reduce chipping

Great for prepping seam joints, miter clean up or a beveled edge profile

Light weight design allows for usage on pneumatic polishers

Can be run wet or dry

TOOLS: ANGLE GRINDER, AIR POLISHER

MATERIALS: ENGINEERED STONE, GRANITE, MARBLE, PORCELAIN/TILE, ULTRA-COMPACT

ITEM #	SIZE	GRIT	FITTING	MAX RPM
CUFCN4C	4"	Coarse 30/40	5/8"- 11	3200 - 6500
CUFCN4M	4"	Medium 50/60	5/8"- 11	3200 - 6500
CUFNC4F	4"	Fine 80/100	5/8"- 11	3200 - 6500

CYCLONE FLAT RESIN CUP WHEEL



Updated coarse grit is more aggressive

Longest lasting cup wheel available

Designed to be used dry or wet

Safer than silicone carbide wheels

Beveled edge helps grind over curved edges with ease

Wet or dry use

TOOLS: ANGLE GRINDER, AIR POLISHER

MATERIALS: CONCRETE, ENGINEERED STONE, GRANITE

ITEM #	SIZE	GRIT	FITTING	MAX RPM
CWFRN4C	4"	Coarse 30	5/8"- 11 thread	11000
CWFRN4M	4"	Medium 50	5/8"- 11 thread	11000
CWFRN4F	4"	Fine 100	5/8"- 11 thread	11000
CWFR50	5"	Coarse 30	5/8"- 11 thread	7500
CWFR5M	5"	Medium 50	5/8"- 11 thread	7500
CWFR5F	5"	Fine 100	5/8"- 11 thread	7500

CYCLONE TURBO CUP WHEEL



Balanced to eliminate vibration and chipping when shaping

Aggressive design with thick turbo segments and diamond content

TOOLS: ANGLE GRINDER

MATERIALS: CONCRETE, ENGINEERED STONE, GRANITE

ITEM #	SIZE	GRIT	FITTING	MAX RPM
CW40	4"	Coarse 30	5/8"- 11 thread	8000
CW40M	4"	Medium 50	5/8"- 11 thread	8000
CW40F	4"	Fine 100	5/8"- 11 thread	8000
CW50	5"	Coarse 30	5/8"- 11 thread	7500
CW60	6"	Coarse 30	5/8"- 11 thread	6000
CW70	7"	Coarse 30	5/8"- 11 thread	5500

GRINDERS/SHAPERS

HURRICANE CUP WHEEL



Balanced to eliminate vibration and chipping when shaping

Aggressive design with thick turbo segments and diamond content

TOOLS: ANGLE GRINDER, AIR POLISHER

MATERIALS: CONCRETE, ENGINEERED STONE, GRANITE

ITEM #	SIZE	GRIT	FITTING	MAX RPM
HCW4C	4"	Coarse 30	5/8"- 11 thread	8000
HCW4M	4"	Medium 50	5/8"- 11 thread	8000
HCW4F	4"	Fine 100	5/8"- 11 thread	8000

DIAMOND CONE



Perfect tool for expanding small holes

Premium diamond leaves a smooth hole

1/4" tip to 1 3/8" diameter

Great for UCS and small tile

Braided diamond so the tool never loses original shape

TOOLS: ANGLE GRINDER, AIR POLISHER

MATERIALS: GRANITE, PORCELAIN/TILE, ULTRA-COMPACT

ITEM #	SIZE	GRIT	FITTING	MAX RPM
CDC100	1/4" tip to 1 3/8" diameter	Fine 100	5/8"- 11	3000 - 4000
CDC300	1 3/8" tip to 3" diameter	Fine 100	5/8"- 11	3000 - 4000

CYCLONE V1 CUTTER/GRINDER



Vacuum brazed, extremely aggressive & versatile tool for edge shaping

Cuts like a blade and shapes like a cup wheel easily with a few passes

Not meant for flat surface grinding

TOOLS: ANGLE GRINDER, AIR POLISHER

MATERIALS: ENGINEERED STONE, GRANITE, PORCELAIN/TILE, ULTRA-COMPACT

ITEM #	SIZE	GRIT	FITTING	MAX RPM
BGC430	4"	Coarse 30	5/8"- 11 thread	8000
BGC450	4"	Medium 50	5/8"- 11 thread	8000
BGC530	5"	Coarse 30	5/8"- 11 thread	7500
BGC550	5"	Medium 50	5/8"- 11 thread	7500
BGC512	5"	Fine 100	5/8"- 11 thread	7500

CYCLONE V2 GRINDER



Vacuum brazed and extremely aggressive for flat edge prep before wet polishing

Can be used in substitution to silica carbide wheels wet or dry

Minimizes dust in shops

Light-weight and easy to use

TOOLS: ANGLE GRINDER, AIR POLISHER

MATERIALS: ENGINEERED STONE, GRANITE, PORCELAIN/TILE, ULTRA-COMPACT

ITEM #	SIZE	GRIT	FITTING	MAX RPM
BVG430	4"	Coarse 30	Velcro back	1500
BVG450	4"	Medium 50	Velcro back	1500
BVG4100	4"	Fine 100	Velcro back	1500

**IF THE SUPER CYCLONE MULTI
CUTTER CAN DO THIS TO DEKTON...**



**IMAGINE WHAT IT CAN DO TO
EVERYTHING ELSE YOU CUT.**

THE EYE OF INNOVATION

Visit DiamaxInc.com for you nearest distributor.



GRINDERS/SHAPERS

CYCLONE ZERO TOLERANCE WHEEL



The most reliable tool for truing vanity sink cut-outs

Available with resin to reduce vibration or segmented for aggressive stock removal

Balanced to eliminate vibration

Oscillate wheel up/down for even wear



SRWC3NR



SRWC1158



SRWC1NR

TOOLS: PNEUMATIC MACHINE

MATERIALS: ENGINEERED STONE, GRANITE

ITEM #	SIZE	GRIT	DESCRIBE	FITTING	MAX RPM
SRWC1158	1"	Coarse 40	Resin	5/8"- 11	8000
SRWC1NR	1"	Coarse 40	No resin	5/8"- 11	8000
SRWC2158	2"	Coarse 40	Resin	5/8"- 11	8000
SRWC2NR	2"	Coarse 40	No resin	5/8"- 11	8000
SRWC3158	3"	Coarse 40	Resin	5/8"- 11	8000
SRWC3NR	3"	Coarse 40	No resin	5/8"- 11	8000

CYCLONE STOCK REMOVAL WHEEL



Available in 36, 60, and 120 grit

Removes radius stock chip-free

Zero vibration

Recommended use: Oscillate wheel up and down to wear evenly and avoid grooves

CYCLONE BRAZED STOCK REMOVAL WHEEL



NEW SIZES

Fastest way to shape a radius on the outside edge or remove material from a sink cut out

Vacuum brazed, wet or dry use

Available in 3 grits: 30, 60, & 100

Comes with center water feed

TOOLS: PNEUMATIC MACHINE

MATERIALS: ENGINEERED STONE, GRANITE

ITEM #	SIZE	GRIT	FITTING	MAX RPM
SRW236	2"	Coarse 36	5/8"- 11 thread	4000
SRW260	2"	Medium 60	5/8"- 11 thread	4000
SRW2120	2"	Fine 120	5/8"- 11 thread	4000
SRW3036	3"	Course 36	5/8"- 11 thread	4000

TOOLS: PNEUMATIC MACHINE, AIR POLISHER

MATERIALS: ENGINEERED STONE, GRANITE, MARBLE, ULTRA-COMPACT

ITEM #	SIZE	GRIT	FITTING	MAX RPM
SRVB230	2"x 2"	Coarse 30	5/8"- 11 thread	4000
SRVB260	2"x 2"	Medium 60	5/8"- 11 thread	4000
SRVB2100	2"x 2"	Fine 100	5/8"- 11 thread	4000
SRVB2038	2"x 3/8"	Coarse 30	5/8"- 11 thread	4000
SRVB2034	2"x 3/4"	Coarse 30	5/8"- 11 thread	4000
SRVB1002	1"x 2"	30 / 40	5/8"- 11 thread	3000 - 4000
SRVB2001	2"x 2"	30 / 40	5/8"- 11 thread	3000 - 4000



SRVB2034



SRVB2038

GRINDERS/SHAPERS

CYCLONE ROUTER BIT SERIES

TOOLS: ROUTER
MATERIALS: ENGINEERED STONE, GRANITE, MARBLE

CYCLONE DEMI BULL ROUTER BIT

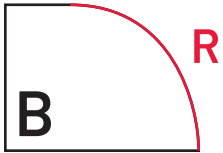

CYCLONE FULL BULL ROUTER BIT



ITEM #	SIZE	SHAPE	POS.	OUTER DIAMETER	RADIUS	BEARING #
RDBC20	20mm	B	#1	75	R = 20	BCDEOG
RDBM20	20mm	B	#2	75	R = 20	BCDEOG
RDBF20	20mm	B	#3	75	R = 20	BCDEOG
RDBC30	30mm	B	#1	95	R = 30	BCDEOG
RDBM30	30mm	B	#2	95	R = 30	BCDEOG
RDBF30	30mm	B	#3	95	R = 30	BCDEOG

ITEM #	SIZE	SHAPE	POS.	OUTER DIAMETER	RADIUS	BEARING #
RFBC20	20mm	V	#1	65	R = 10	BCFBUL
RFBM20	20mm	V	#2	65	R = 10	BCFBUL
RFBC30	30mm	V	#1	70	R = 15	BCFBUL
RFBM30	30mm	V	#2	70	R = 15	BCFBUL
RFBC40	40mm	V	#1	75	R = 20	BCFB40
RFBM40	40mm	V	#2	75	R = 20	BCFB40

CYCLONE OGEE ROUTER BIT



CYCLONE BEVEL ROUTER BIT



ITEM #	SIZE	SHAPE	POS.	OUTER DIAMETER	RADIUS	BEARING #
ROGC20	20mm	F	#1	75	R = 20	BCDEOG
ROGM20	20mm	F	#2	75	R = 20	BCDEOG
ROGC25	25mm	F	#1	85	R = 25	BCDEOG
ROGM25	25mm	F	#2	85	R = 25	BCDEOG
ROGC30	30mm	F	#1	95	R = 30	BCDEOG
ROGM30	30mm	F	#2	95	R = 30	BCDEOG

ITEM	SIZE	SHAPE	POS.	OUTER DIAMETER	LENGTH	BEARING #
RBVZ20	20mm	E	0	65	L1 = 20, L2 = 5	BCDEOG
RBVC20	20mm	E	1	65	L1 = 20, L2 = 5	BCDEOG
RBVC25	25mm	E	1	75	L1 = 30, L2 = 5	BCDEOG

CYCLONE BREAKER BIT



For use on 2 cm - 4 cm material

Ultra-aggressive segmented diamond "breaks" the edge of the hardest granite to extend the life of your sintered profiles

Max RPM 6000

ITEM #	SIZE	DESCRIPTION	BEARING
RDBB	30mm - 50mm	Double bevel breaker bit	BCDEOG

GRINDERS/SHAPERS

HURRICANE ROUTER BIT SERIES

TOOLS: ROUTER

MATERIALS: ENGINEERED STONE, GRANITE, MARBLE

HURRICANE HALF BULL ROUTER

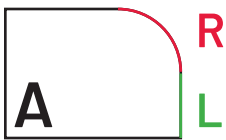

ITEM #	SIZE	SHAPE	POS.	OUTER DIAMETER	RADIUS/LENGTH	BEARING #
RHHB20Z	20mm	A	0	65	R = 10, L = 10	BHHALF
RHHB20C	20mm	A	1	65	R = 10, L = 10	BHHALF
RHHB30Z	30mm	A	0	75	R = 15, L = 15	BHHALF
RHHB30C	30mm	A	1	75	R = 15, L = 15	BHHALF
RHHB30M	30mm	A	2	75	R = 15, L = 15	BHHALF
RHHB30F	30mm	A	3	75	R = 15, L = 15	BHHALF

HURRICANE DEMI BULL ROUTER



ITEM #	SIZE	SHAPE	POS.	OUTER DIAMETER	RADIUS	BEARING #
RHDB20Z	20mm	B	0	85	R = 20	BHDEOG
RHDB20C	20mm	B	1	85	R = 20	BHDEOG
RHDB20M	20mm	B	2	85	R = 20	BHDEOG
RHDB20F	20mm	B	3	85	R = 20	BHDEOG
RHDB30Z	30mm	B	0	105	R = 30	BHDEOG
RHDB30C	30mm	B	1	105	R = 30	BHDEOG
RHDB30F	30mm	B	3	105	R = 30	BHDEOG

HURRICANE BEVEL ROUTER

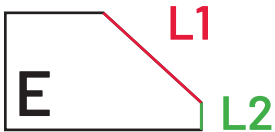

ITEM #	SIZE	SHAPE	POS.	OUTER DIAMETER	LENGTH	BEARING #
RHBV20Z	20mm	E	0	75	L = 28, L2 = 1	BHDEOG
RHBV20C	20mm	E	1	75	L = 28, L2 = 1	BHDEOG
RHBV25C	25mm	E	1	85	L = 35, L2 = 2	BHDEOG
RHBV30Z	30mm	E	0	90	L = 40, L2 = 3	BHDEOG
RHBV30M	30mm	E	2	90	L = 40, L2 = 3	BHDEOG

HURRICANE OGEE ROUTER

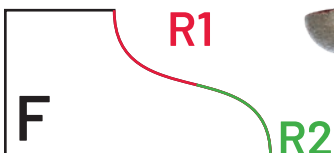

ITEM #	SIZE	SHAPE	POS.	OUTER DIAMETER	RADIUS	BEARING #
RHOG20Z	20mm	F	0	80	R1 = R2 = 10	BHDEOG
RHOG20C	20mm	F	1	80	R1 = R2 = 10	BHDEOG
RHOG20M	20mm	F	2	80	R1 = R2 = 10	BHDEOG
RHOG20F	20mm	F	3	80	R1 = R2 = 10	BHDEOG
RHOG25Z	25mm	F	0	90	R1 = R2 = 12.5	BHDEOG
RHOG25C	25mm	F	1	90	R1 = R2 = 12.5	BHDEOG
RHOG25M	25mm	F	2	90	R1 = R2 = 12.5	BHDEOG
RHOG30Z	30mm	F	0	90	R1 = R2 = 16.5	BHDEOG
RHOG30C	30mm	F	1	90	R1 = R2 = 16.5	BHDEOG
RHOG30M	30mm	F	2	90	R1 = R2 = 16.5	BHDEOG
RHOG30F	30mm	F	3	90	R1 = R2 = 16.5	BHDEOG
RHOB40C	40mm	FB	1	90	R1 = 12 R2 = 16	BHFBUL

GRINDERS/SHAPERS

HURRICANE ROUTER BIT SERIES

TOOLS: ROUTER
MATERIALS: ENGINEERED STONE, GRANITE, MARBLE

HURRICANE WATERFALL ROUTER



ITEM #	SIZE	SHAPE	POS.	OUTER DIAMETER	RADIUS	BEARING #
RHWF30Z	30mm	3G	0	100	R = R2 = R3 = 10	BHHALF
RHWF30C	30mm	3G	1	100	R = R2 = R3 = 10	BHHALF
RHWF30M	30mm	3G	2	100	R = R2 = R3 = 10	BHHALF
RHWF30F	30mm	3G	3	100	R = R2 = R3 = 10	BHHALF

HURRICANE DUPONT ROUTER

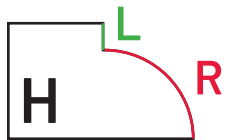

ITEM #	SIZE	SHAPE	POS.	OUTER DIAMETER	RADIUS/LENGTH	BEARING #
RHH20Z	20mm	H	0	70	R = 15, L = 5	BHDEOG
RHH20C	20mm	H	1	70	R = 15, L = 5	BHDEOG
RHH30Z	20mm	H	0	70	R = 15, L = 5	BHDEOG
RHH30C	30mm	H	1	70	R = 15, L = 5	BHDEOG

HURRICANE COVE ROUTER



ITEM #	SIZE	SHAPE	POS.	OUTER DIAMETER	RADIUS/LENGTH	BEARING #
RHC20C	20mm	L	1	60	R = 10, L = 10	BHB001
RHC20F	20mm	L	3	60	R = 10, L = 10	BHB001

HURRICANE COVE DUPONT ROUTER



ITEM #	SIZE	SHAPE	POS.	OUTER DIAMETER	RADIUS/ LENGTH	BEARING #
RHCD20Z	20mm	O	0	79	R1 = R2 = 8.5, L = 3	BHDEOG
RHCD30Z	30mm	O	0	90	R1 = R2 = 12 L = 6	BHDEOG
RHCD30F	30mm	O	3	90	R1 = R2 = 12 L = 6	BHDEOG

GRINDERS/SHAPERS

HURRICANE ROUTER BIT SERIES

TOOLS: ROUTER
MATERIALS: ENGINEERED STONE, GRANITE, MARBLE

HURRICANE PENCIL ROUTER



ITEM #	SIZE	SHAPE	POS.	OUTER DIAMETER	RADIUS	BEARING #
RHPEN30C	30mm	PE	1	50	R = 28	BHB002
RHPEN30M	30mm	PE	2	50	R = 28	BHB002
RHPEN40C	40mm	PE	1	55	R = 35	BHB002
RHPEN40M	40mm	PE	2	55	R = 35	BHB002

HURRICANE COVE/OGEE ROUTER



ITEM #	SIZE	SHAPE	POS.	OUTER DIAMETER	RADIUS	BEARING #
RHC030Z	30mm	Q	0	100	R1 = R2 = R3 = 11.5	BHDE0G
RHC030C	30mm	Q	1	100	R1 = R2 = R3 = 11.5	BHDE0G
RHC030F	30mm	Q	3	100	R1 = R2 = R3 = 11.5	BHDE0G

HURRICANE DOUBLE EASED ROUTER

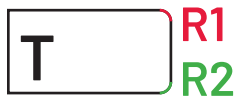

ITEM #	SIZE	SHAPE	POS.	OUTER DIAMETER	RADIUS	BEARING #
RHDE20Z	20mm	T	0	50	R1 = R2 = 5	BHB002

HURRICANE FULL BULL ROUTER



ITEM #	SIZE	SHAPE	POS.	OUTER DIAMETER	RADIUS	BEARING #
RHFB20C	20mm	V	1	60	R = 10	BHFBUL
RHFB20F	20mm	V	3	60	R = 10	BHFBUL
RHFB30Z	30mm	V	0	65	R = 15	BHFBUL
RHFB30C	30mm	V	1	65	R = 15	BHFBUL
RHFB30M	30mm	V	2	65	R = 15	BHFBUL
RHFB30F	30mm	V	3	65	R = 15	BHFBUL
RHFB40Z	40mm	V	0	80	R = 20	BHFBUL
RHFB40C	40mm	V	1	80	R = 20	BHFBUL
RHFB40M	40mm	V	2	80	R = 20	BHFBUL
RHFB40F	40mm	V	3	80	R = 20	BHFBUL
RHFB60Z	60mm	V	0	95	R = 30	BHFBUL
RHFB60C	60mm	V	1	95	R = 30	BHFBUL

CLUSTER PUCKS



NEW

Aggressive segment design for fast adhesive removal while leaving a tight scratch pattern

Only 1 step needed for grinding before transition/ceramic or resin pads

Multiple points create fast cutting to increase your pace and get the job done!



Specially designed segments to cut through adhesive without clogging

Universal backing to fit the most popular concrete grinders

TOOLS: CONCRETE GRINDING MACHINE

MATERIALS: CONCRETE

ITEM #	SIZE	GRIT	FITTING
CCFD3030	3"	30	Universal backing with adapter plate
CCFD3050	3"	50	Universal backing with adapter plate
CCFD3100	3"	100	Universal backing with adapter plate

CYCLONE PCD (POLYCRYSTALLINE DIAMOND) WHEEL



PCD grinding wheels are designed for aggressive removal of hard and tacky surfaces such as:

Urethane epoxy

Waterproofing membrane

Pool deck coating

Thick mastic

Paint

VCT/carpet glues

TOOLS: ANGLE GRINDER

MATERIALS: CONCRETE

ITEM #	SIZE	ARBOR	GRIT	SEGMENTS	BODY
CPCDM5	5"	7/8"	Medium 50/60	Steel	Steel
CPCDM7	7"	7/8"	Medium 50/60	Steel	Steel

Rubber gasket included



CYCLONE DIAMOND CLUSTER GRINDING WHEEL



First lightweight grinding wheel for pneumatic tools

Diamond cluster points rip away epoxy and fiberglass backing

Great for removing resin polish to prepare slab for honing and can be used effectively for fast edge shaping

Can be used Wet or Dry

TOOLS: ANGLE GRINDER, AIR POLISHER

MATERIALS: CONCRETE, ENGINEERED STONE, GRANITE

ITEM #	SIZE	BODY	GRIT	FITTING	RPM
SCRG4	4"	Fiberglass	Medium 50	5/8"- 11	15300
SCRG5	5"	Fiberglass	Medium 50	5/8"- 11	12200
SCRG5C	5"	Fiberglass	Coarse 30	5/8"- 11	12200
SCRG5F	5"	Fiberglass	Fine 100	5/8"- 11	12200
SCRG6	6"	Fiberglass	Medium 50	5/8"- 11	10000
SCRG7	7"	Fiberglass	Medium 50	5/8"- 11	5500
SCRG5MB	5"	Steel	Medium 50	5/8"- 11	12200
SCRG6MB	6"	Steel	Medium 50	5/8"- 11	10000
SCRG7MB	7"	Steel	Medium 50	5/8"- 11	5500



CNC TOOLING



KEY FEATURES

Wide range of sizes
and lengths available

Get 700 holes from the
Cyclone S CNC core bit

First finger bits to come
with a bottom segment

Extra strong welds lock
segments into place



CNC TOOLING

CYCLONE ULTRA CNC CORE BIT



T-segment design with new diamond technology increases life and minimizes segment loss

Designed with slot-openings on each side which prevents blow-outs

TOOLS: CNC MACHINE

MATERIALS: ENGINEERED STONE, GRANITE, PORCELAIN/TILE, ULTRA-COMPACT

ITEM #	SIZE	FITTING	USABLE LENGTH	MAX RPM
CUBYH138	1 3/8"	1/2" gas	2.25"	2300
CUBYH114	1 1/4"	1/2" gas	2.25"	2300
CUBYH112	1 1/2"	1/2" gas	2.25"	2300

CYCLONE S THIN WALL



Designed with a very fine diamond
Gives you clean, fast holes every time

Thin continuous rim segment

CYCLONE S CNC CORE BIT PARAMETERS

RPM	FEED RATE
1250	1" - 2"/ minute

TOOLS: CNC MACHINE

MATERIALS: ENGINEERED STONE, GRANITE

ITEM #	SIZE	FITTING	USABLE LENGTH	MAX RPM
CDBHTW114	1 1/4"	1/2 gas male	2 1/2"	1250
CDBHTW138	1 3/8"	1/2 gas male	2 1/2"	1250
CDRTW138	1 3/8"	1/2 gas male, <i>reverse</i>	2 1/2"	1250
CDBHTW112	1 1/2"	1/2 gas male	2 1/2"	1250

CYCLONE CNC CORE BIT



T-segment design with new diamond technology increases life and minimizes segment loss

Designed with slot-openings on each side which prevents blow-outs

Feed Rate: 30mm slab/2 IPM

TOOLS: CNC MACHINE

MATERIALS: ENGINEERED STONE, GRANITE

ITEM #	SIZE	FITTING	USABLE LENGTH	MAX RPM
CDBYH114	1 1/4"	1/2 gas male	3"	2300
CDBYH138	1 3/8"	1/2 gas male	3"	2300
CDBYH112	1 1/2"	1/2 gas male	3"	2300
CDBHR138	1 1/2"	1/2 gas male, <i>reverse</i>	3"	2300
CDBYH012	1/2"	1/2 gas male	3"	2300
CDBYH014	1/4"	1/2 gas male	3"	2300
CDBYH034	3/4"	1/2 gas male	3"	2300
CDBYH036	3/16"	1/2 gas male	3"	2300
CDBYH038	3/8"	1/2 gas male	3"	2300
CDBYH100	1"	1/2 gas male	3"	2300
CDBHR014	1/4"	1/2 gas male, <i>reverse</i>	3"	2300
CDBYH200	2"	1/2 gas male	3"	2300



CYCLONE ULTRA CNC FINGER BIT



Specific metal bond and diamond composition provide fast and clean milling in porcelain and ultra compact material

8 segment design ensures well balanced smooth cut

TOOLS: CNC MACHINE

MATERIALS: ENGINEERED STONE, GRANITE, PORCELAIN/TILE, ULTRA-COMPACT

ITEM #	SEGMENT SIZE	SEGMENT #	FITTING	MAX RPM
CUFD2025	20mm x 25Lmm	8	1/2" gas	4500
CUFD2030	20mm x 30Lmm	8	1/2" gas	4500
CUFD2035	20mm x 35Lmm	8	1/2" gas	4500
CUFD2040	20mm x 40Lmm	8	1/2" gas	4500

SUPER CYCLONE HIGH-SPEED FINGER BIT



The Super Cyclone Seven Segment Finger Bit has a smaller diameter designed to cut even faster

Bottom segment enables drilling into slab like a core bit

TOOLS: CNC MACHINE

MATERIALS: ENGINEERED STONE, GRANITE

ITEM #	SEGMENT SIZE	SEGMENT	FITTING	MAX RPM	HIGH-SPEED PARAMETERS	
					RPM	FEED RATE
FBSHS158	1 5/8" x 22mm segment length 40mm	7 with bottom	1/2 gas male	4500 - 6000	5500	20" / minute
FB158TS	1 5/8" x 22mm segment length 40mm	8 twin	1/2 gas male	4500 - 6000	5000	15" / minute
FBSHS200	2" x 22mm segment length 50mm	7 with bottom	1/2 gas male	4500 - 6000	4500	12" / minute

CYCLONE FINGER BIT



Bottom segment gives the CNC operator the option of drilling into the slab

The 6 segment finger bit has the first ever reverse apple core design which is thicker in the middle

TOOLS: CNC MACHINE

MATERIALS: ENGINEERED STONE, GRANITE

ITEM #	SEGMENT SIZE	SEGMENT	FITTING	MAX RPM	6 SEGMENT PARAMETERS	
					RPM	FEED RATE
FB158	1 5/8" x 22mm segment length 40mm	6 with bottom	1/2 gas male	4500 - 5000	5500	12" / minute
FB1212	2 1/2" x 22mm segment length 65mm	5 with bottom	1/2 gas male	4500 - 5000	5000	10" / minute
FBRT158	Reverse thread 1 5/8" x 22mm segment length 40mm	6 with bottom	1/2 gas male	4500 - 5000	4500	8" / minute

CYCLONE COMBO FINGER BIT



NEW

- Faster incremental cutting with larger bottom segment
- Up to 3/8" stock removal per pass
- Overall cutting time shorter by 60%
- Fastest cutting finger bit for 5 axis saws

TOOLS: CNC MACHINE
MATERIALS: ENGINEERED STONE, GRANITE

ITEM #	SEGMENT SIZE	SEGMENT	FITTING	MAX RPM	FEED RATE
FBCC158	1 5/8" x 22mm segment length 40mm	8 twin w/ bottom non-core	1/2" gas	4500 - 5200	12" - 17" / min
FBCR158	1 5/8" X 22mm segment length 40mm	8 twin w/ bottom non-core	1/2" gas reverse	4500 - 5200	12" - 17" / min

CYCLONE Z WHEEL



- Available in both 60mm and 80mm diameters
- Ultra-aggressive design for fast work at minimal spindle load
- Extends the life of the first position of profile bits

TOOLS: CNC MACHINE
MATERIALS: ENGINEERED STONE, GRANITE

ITEM #	DIAMETER	FITTING	SEGMENT	MAX RPM
CNZW6045	60mm x 40mm	35mm bore	15	6000
CNZW8035	80mm x 35mm	35mm bore	21	6000
CNZW8045	80mm x 45mm	35mm bore	21	6000

FEED RATE: 110" / MIN @ 5MM removal per pass

CYCLONE CNC CALIBRATING WHEEL



- CNC Calibration Wheels prepare the slab by reducing the thickness
- Approximate Recommended Feed Rate is .87" to 1.75" per minute

TOOLS: CNC MACHINE
MATERIALS: ENGINEERED STONE, GRANITE

ITEM #	SIZE	FITTING	SEGMENTS	MAX RPM
CGW025	4"	50mm, 3+3 holes	25	4000 - 5000
CGW032	4"	50mm, 3+3 holes	32	4000 - 5000

CYCLONE INCREMENTAL BIT & MANDREL



FBSTIP-M (mandrel)

For use on sink cut-out machines

Super Cyclone screw on tip is taller and lasts longer for more cutouts with less glazing issues

Reverse thread options available

TOOLS: CNC MACHINE

MATERIALS: ENGINEERED STONE, GRANITE, MARBLE

MANDRELS

ITEM #	DESCRIPTION	SHAFT LENGTH	FITTING
FBSTIP-M	Cyclone mandrel with sleeve	70mm	M12 female - 1/2 gas male
FBSM-RT	Super Cyclone mandrel reverse thread	70mm	M12 female - 1/2 gas male
FBSM35	Super Cyclone Mandrel Thread (short)	35mm	M12 female - 1/2 gas male
FBSM-RT25	Super Cyclone mandrel with reverse thread (short)	25mm	M12 female - 1/2 gas male



Soft Bond

FBSTIP



Hard Bond

FBSTIP-S



Hard Bond

FBSTIP-T



Hard Bond

FBSTIP-RT

ITEM #	SIZE	FITTING	USABLE LENGTH	BOND	RPM	FEED RATE
FBSTIP	20mm	M12	20mm	Soft	4000	30 - 40 IPM
FBSTIP-S	20mm	M12	22mm	Hard	4000	30 - 40 IPM
FBSTIP-T	20mm	M12	15mm	Hard	4000	30 - 40 IPM
FBSTIP-RT	20mm	M12 reverse thread	22mm	Hard	5500	30 - 40 IPM

CYCLONE ULTRA INCREMENTAL BIT



For use on sink cut-out machines

Specific metal bond and diamond composition provide fast and clean milling in porcelain and ultra compact material

Micro incremental bits are designed for cutting at faster speeds. Used to mill tight corners and outlet holes.

Reverse thread options available



FBSM-RT25 (mandrel)

TOOLS: CNC MACHINE

MATERIALS: PORCELAIN/TILE, ULTRA-COMPACT

ITEM #	DIAMETER	USABLE LENGTH	FITTING	BOND	RPM
FBTU2020	20mm	20mm	M12	Medium	4200
FBTU20RT	20mm	20mm	Reverse M12	Medium	4200

MICRO INCREMENTAL BITS

ITEM #	DIAMETER	USABLE LENGTH	FITTING	BOND	RPM
FBTU08RT	8mm	15mm	Reverse 1/2 gas	Medium	4200
FBTU10RT	10mm	15mm	Reverse 1/2 gas	Medium	4200
FBTU0815	8mm	15mm	1/2 gas	Medium	4200
FBTU1015	10mm	15mm	1/2 gas	Medium	4200

MANDRELS

ITEM #	DESCRIPTION	FITTING
FBSTIP-M	Cyclone Mandrel with sleeve, 70mm length	M12 female - 1/2 gas male
FBSM-RT	Cyclone mandrel reverse thread, 70mm length	M12 female - 1/2 gas male
FBSM35	Super Cyclone Mandrel Thread (short)	M12 female - 1/2 gas male
FBSM-RT25	Cyclone mandrel with reverse thread, 25mm length	M12 female - 1/2 gas male

AUTO MACHINE TOOLING



KEY FEATURES

Cyclone S comes with white resin and 15mm segments

Specs for every machine included with wheels with Cyclone S

Field tested for a minimum of 3500 linear feet of polishing

Honeycomb design traps water for extra life & high polish on Cyclone Straight Wheels



AUTO MACHINE TOOLING

CYCLONE ULTRA STRAIGHT EDGE SNAIL LOCK WHEEL



Provides all the great features of the Cyclone version at a more competitive price

Outperforms other industry brands at the same price point level

More forgiving when polishing engineered stone with minimal water

CYCLONE ULTRA STRAIGHT EDGE VELCRO WHEEL



Provides all the great features of the Cyclone version at a more competitive price

Outperforms other industry brands at the same price point level

More forgiving when polishing engineered stone with minimal water

TOOLS: AUTO-EDGE MACHINE
MATERIALS: ENGINEERED STONE, GRANITE

GRIT	5"	6"	FITTING	RPM
50	CUW50050	CUW60050	Snail lock	Reference your machine specifications
100	CUW50100	CUW60100	Snail lock	
200	CUW50200	CUW60200	Snail lock	
400	CUW50400	CUW60400	Snail lock	
800	CUW50800	CUW60800	Snail lock	
1500	CUW51500	CUW61500	Snail lock	
3000	CUW53000	CUW63000	Snail lock	

TOOLS: AUTO-EDGE MACHINE
MATERIALS: ENGINEERED STONE, GRANITE

GRIT	5"	6"	FITTING	RPM
50	CUV50050	CUV60050	Velcro	Reference your machine specifications
100	CUV50100	CUV60100	Velcro	
200	CUV50200	CUV60200	Velcro	
400	CUV50400	CUV60400	Velcro	
800	CUV50800	CUV60800	Velcro	
1500	CUV51500	CUV61500	Velcro	
3000	CUV53000	CUV63000	Velcro	
Accessory	BPSL50	BPSL60	Snail lock	



AUTO MACHINE TOOLING

CYCLONE S HYBRID WHEELS



Designed for straight & bull nose edges

White resin to polish white quartz as well as granite

15mm thickness for Diamax's longest lasting auto edge wheel

For use on all multi-head in-line polishing machines



New Cyclone S Hybrid Wheel 15mm thickness



Old Cyclone S Hybrid Wheel

TOOLS: AUTO-EDGE MACHINE

MATERIALS: ENGINEERED STONE, GRANITE, MARBLE, QUARTZITE

GRIT	5"	6"	FITTING	RPM
60	CSH50060	CSH60060	Snail lock	
120	CSH50120	CSH60120	Snail lock	
220	CSH50220	CSH60220	Snail lock	
400	CSH50400	CSH60400	Snail lock	
800	CSH50800	CSH60800	Snail lock	Reference your
1800	CSH51800	CSH61800	Snail lock	machine
3500	CSH53500	CSH63500	Snail lock	specifications

CYCLONE STRAIGHT EDGE WHEELS



The Cyclone Straight Edge Wheels work on most automatic back-splash machines. They give an exceptional and superior smooth finish in comparison to epoxy wheels. Their long life reduces pad change downtime.

TOOLS: AUTO-EDGE MACHINE

MATERIALS: ENGINEERED STONE, GRANITE, MARBLE, QUARTZITE

GRIT	4"	5"	FITTING
50	SEW40050	SEW50050	Snail lock
100	SEW40100	SEW50100	Snail lock
200	SEW40200	SEW50200	Snail lock
400	SEW40400	SEW50400	Snail lock
800	SEW40800	SEW50800	Snail lock
1500	SEW41500	SEW51500	Snail lock
3000	SEW43000	SEW53000	Snail lock
Black buff	SEW4BB	SEW5BB	Snail lock

OPERATING PARAMETERS: Start at 40-60 cm/min for granite. Find suitable speed according to stone material. 40-60 cm/min for profile polishing on engineered stone. Water: 50 liter/min.

CYCLONE WHITE STRAIGHT EDGE WHEELS

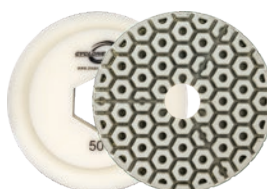

Designed to be used on white and light colored materials without bleeding

Gives an exceptional and superior smooth finish in comparison to epoxy wheels.

TOOLS: AUTO-EDGE MACHINE

MATERIALS: ENGINEERED STONE, GRANITE, MARBLE

GRIT	4"	FITTING
50	SEWR40050	Snail lock
100	SEWR40100	Snail lock
200	SEWR40200	Snail lock
400	SEWR40400	Snail lock
800	SEWR40800	Snail lock
1500	SEWR41500	Snail lock
3000	SEWR43000	Snail lock
White buff	SEWR4W	Snail lock

OPERATING PARAMETERS: Start at 40-60 cm/min for granite. Find suitable speed according to stone material. 40-60 cm/min for profile polishing on engineered stone. Water: 50 liter/min.

CYCLONE S WHEELS SUGGESTED PARAMETERS

BRETON EASYEDGE V 7S STRAIGHT EDGE

Cyclone S Straight Edge
Grits: 60, 120, 220, 400, 800, 1800, 3500
Pressure: 1.75 - 2 BAR
Speed: 35 - 45 CM/MIN

BRETON PLATINUM EDGE V 7S BULLNOSE & STRAIGHT EDGE

Cyclone S Hybrid Straight & Profile Edge
Grits: 60, 120, 220, 400, 800, 1800, 3500
Pressure: 1.75 - 2 BAR
Speed: 35 - 40 CM/MIN

COMANDULLI OMEGA 60 BULLNOSE & STRAIGHT EDGE

Cyclone S Hybrid Straight & Profile Edge
Grits: 120, 220, 400, 800, 1800, 3500
Pressure: 2.5 - 3.0 BAR
Speed: 20 - 25 CM/MIN

COMANDULLI OMEGA 100 BULLNOSE & STRAIGHT EDGE

Cyclone S Hybrid Straight & Profile Edge
Grits: 60, 120, 220, 400, 800, 1800, 3500
Pressure: 2.5 - 3.0 BAR
Speed: 25 - 35 CM/MIN

COMANDULLI PENTA STRAIGHT EDGE

Cyclone S Straight Edge
Grits: 220, 400, 800, 1800, 3500
Pressure: 2.6 - 3.0 BAR
Speed: 30 - 35 CM/MIN

COMANDULLI SYNTHESIS BULLNOSE & STRAIGHT EDGE

Cyclone S Hybrid Straight & Profile Edge
Grits: 60, 120, 220, 400, 800, 1800, 3500
Pressure: 2.5 - 3.0 BAR
Speed: 25 - 35 CM/MIN

MARMO MECCANICA LCT521 BULLNOSE & STRAIGHT EDGE

Cyclone S Hybrid Straight & Profile Edge
Grits: 120, 220, 400, 800, 1800
Pressure: 2.5 - 3.0 BAR
Speed: 35 - 45 CM/MIN

MARMO MECCANICA LCT522 BULLNOSE & STRAIGHT EDGE

Cyclone S Hybrid Straight & Profile Edge
Grits: 120, 220, 400, 800, 1800, 3500
Pressure: 2.6 - 2.8 BAR
Speed: 20 - 25 CM/MIN

MARMO MECCANICA LCV711 STRAIGHT EDGE

Cyclone S Straight Edge
Grits: 120, 220, 400, 800, 1800, 3500
Pressure: 2.6 - 3.0 BAR
Speed: 30 - 40 CM/MIN

MARMO MECCANICA LTV BULLNOSE & STRAIGHT EDGE

Cyclone S Hybrid Straight & Profile Edge
Grits: 120, 220, 400, 800, 1800, 3500
Pressure: 2.6 - 2.8 BAR
Speed: 20 - 25 CM/MIN

PARK INDUSTRIES FASTBACK STRAIGHT EDGE

Cyclone S Straight Edge
Grits: 60, 120, 220, 400, 800, 1800, 3500
Pressure: 45 - 50 PSI
Speed: 13" - 17" / MIN

PARK INDUSTRIES VELOCITY BULLNOSE AND STRAIGHT EDGE

Cyclone S Hybrid Straight & Profile Edge
Grits: 120, 220, 400, 800, 1800, 3500
Pressure: 36 - 40 PSI
Speed: 9.8" / MIN

Speed Control: 18%
Miter Speed: 98 Degrees/sec
Speed Control: 70%
Active Size: 1.625"
Hold down Pressure: 55 Psi

MONTRESOR LARA 60 BULLNOSE & STRAIGHT EDGE

Cyclone S Hybrid Straight & Profile Edge
Grits: 120, 220, 400, 800, 1800, 3500
Pressure: 2.6 - 2.8 BAR
Speed: 20 - 25 CM / MIN

MONTRESOR LARA 80 BULLNOSE & STRAIGHT EDGE

Cyclone S Hybrid Straight & Profile Edge
Grits: 60, 120, 220, 400, 800, 1800, 3500
Pressure: 2.5 - 3.0 BAR
Speed: 25 - 35 CM / MIN

MONTRESOR LUNA 740, LUNA 780 AND LUNA 880 BULLNOSE & STRAIGHT EDGE

Cyclone S Hybrid Straight & Profile Edge
Grits: 120, 220, 400, 800, 1800, 3500
Pressure: 2.6 - 2.8 BAR
Speed: 20 - 25 CM / MIN

SASSO MECCANICA FLYING BULL BULLNOSE & STRAIGHT EDGE

Cyclone S Hybrid Straight & Profile Edge
Grits: 120, 220, 400, 800, 1800, 3500
Pressure: 4.0 - 4.2 BAR
Speed: 30 - 35 CM / MIN

SASSO MECCANICA FLYING FLAT STRAIGHT EDGE

Cyclone S Straight Edge
Grits: 60, 120, 220, 400, 800, 1800, 3500
Pressure: 4.0 - 4.2 BAR
Speed: 35 - 40 CM / MIN

SASSO MECCANICA TE EXPERIENCE BULLNOSE & STRAIGHT EDGE

Cyclone S Hybrid Straight & Profile Edge
Grits: 60, 120, 220, 400, 800, 1800, 3500
Pressure: 4.0 - 4.2 BAR
Speed: 30 - 35 CM / MIN

AUTO MACHINE TOOLING

CYCLONE COPPER EDGE WHEEL

Save your resin wheel! Transition bond from bridge saw to resin

Increases polish speed by 40%

Aggressive copper hybrid bond easily trues out imperfect edges

Faster and longer lasting at over 10k linear feet @ 65"/min +

TOOLS: AUTO-EDGE MACHINE

MATERIALS: ENGINEERED STONE, GRANITE, MARBLE, QUARTZITE

GRIT	5" ITEM #	6" ITEM #	FEED RATE	PRESSURE
30	CHW50030	CHW60030	65"/min	38 psi
50	CHW50050	CHW60050	65"/min	38 psi
100	CHW50100	CHW60100	65"/min	24 psi
200	CHW50200	CHW60200	65"/min	24 psi
400	CHW50400	CHW60400	65"/min	20 psi
800	CHW50800	CHW60800	65"/min	20 psi
1500	CHW51500	CHW61500	65"/min	20 psi
3000	CHW53000	CHW63000	65"/min	20 psi



CYCLONE SNAIL LOCK SYSTEM

Fits most auto-edge profile machines with new formula which ensures even wear and longer life

Best for bull nose shaping & polishing

Copper bonded pos. 3 ensures longer life compared to standard resin

For RPM please consult your machine technical specs

TOOLS: AUTO-EDGE MACHINE

MATERIALS: ENGINEERED STONE, GRANITE

ITEM #	SIZE	POS.	BOND	FITTING	WORKING PARAMETER
CCWSL41	4"	1	Metal	Snail lock	90 - 100 PSI
CCWSL42	4"	2	Metal	Snail lock	90 - 100 PSI
CWSLP3	4"	3	Resin	Velcro back	30 - 35 PSI
CWSLP3C	4"	3	Copper	Velcro back	30 - 35 PSI
CWSLP4	4"	4	Resin	Velcro back	30 - 35 PSI
CWSLP5	4"	5	Resin	Velcro back	30 - 35 PSI
CWSLP6	4"	6	Resin	Velcro back	30 - 35 PSI





CYCLONE COPPER EDGE WHEEL

Save your resin wheel!
Transition bond from
bridge saw to resin

Increases polish
speed by 40%

Aggressive copper
hybrid bond easily trues
out imperfect edges

Faster and longer
lasting at over 10k linear
feet @ 65"/min +



TILE & GLASS



KEY FEATURES

Innovative tools for your
tile needs

Cyclone mesh turbo never
gets hot when dry cutting

First ever dry porcelain
drill bit



CYCLONE ULTRA MESH TURBO BLADE

The Cyclone Ultra Mesh Turbo blade is designed to cut Ultra Compact surfaces at a fast speed with minimal chipping

Ultra thin rim assures a fast clean cut

Turbo mesh design allows for optimal cooling

Center hub reinforcement keeps the blade cutting straight

TOOLS: ANGLE GRINDER, HAND SAW

MATERIALS: ENGINEERED STONE, GRANITE, MARBLE, PORCELAIN/TILE, QUARTZITE, ULTRA-COMPACT

ITEM #	SIZE	ARBOR	MAX RPM
CUTB40	4"	7/8" + 20mm + 5/8", reinforced hub	13200
CUTB45	4 1/2"	7/8" + 20mm + 5/8", reinforced hub	13200
CUTB50	5"	7/8" + 20mm + 5/8", reinforced hub	12200
CUTB60	6"	7/8" + 20mm + 5/8", reinforced hub	10000
CUTB70	7"	5/8" + DK0, reinforced hub	8600
CUTB10	10"	1" + 5/8" + 7/8", reinforced hub	6100



TILE & GLASS

CYCLONE ULTRA CORE BIT



NEW SIZES

Specific grit & bond composition provides a fast clean hole through porcelain & other ultra compact material

Featuring thin beveled segments for ease of entry into material

Shortened overall length for added controllability

Wet or dry use

CYCLONE PORCELAIN TILE BIT



First ever dry bit for porcelain tile

Sintered turbo rim for faster cuts and longer life

Comes with hexagonal chuck

Can be used on ultra compact material with water

TOOLS: ANGLE GRINDER, PNEUMATIC MACHINE, DRILL, AIR POLISHER
MATERIALS: GRANITE, MARBLE, PORCELAIN/TILE, QUARTZITE, ULTRA-COMPACT

TOOLS: PNEUMATIC MACHINE
MATERIALS: ENGINEERED STONE, GRANITE, MARBLE, PORCELAIN/TILE, ULTRA-COMPACT

ITEM #	SIZE	FITTING	USABLE LENGTH	MAX RPM
CUDB100	1"	5/8" - 11	2.25"	5000
CUDB114	1 1/4"	5/8" - 11	2.25"	5000
CUDB138	1 3/8"	5/8" - 11	2.25"	5000
CUDB112	1 1/2"	5/8" - 11	2.25"	5000
CUDB134	1 3/4"	5/8" - 11	2.25"	5000
CUDB200	2"	5/8" - 11	2.25"	5000
CUDB214	2 1/4"	5/8" - 11	2.25"	5000
CUDB212	2 1/2"	5/8" - 11	2.25"	5000
CUDB300	3"	5/8" - 11	2.25"	5000
CUDB312	3.5"	5/8" - 11	2.25"	5000
CUDB212	4"	5/8" - 11	2.25"	5000

ITEM #	SIZE (MM)	FITTING	USABLE LENGTH	RPM
TDBC316	3/16" (5mm)	Hexagonal chuck	2 1/4"	1500 - 2000
TDBC14	1/4" (6mm)	Hexagonal chuck	2 1/4"	1500 - 2000
TDBC516	5/16" (8mm)	Hexagonal chuck	2 1/4"	1500 - 2000
TDBC38	3/8" (10mm)	Hexagonal chuck	2 1/4"	1500 - 2000
TDBC12	1/2" (12mm)	Hexagonal chuck	2 1/4"	1500 - 2000



ITEM #	SIZE	FITTING	USABLE LENGTH	MAX RPM	BOND
CUDB014	1/4"	5/8" - 11	2"	5000	Medium
CUDB516	5/16"	5/8" - 11	2"	5000	Medium
CUDB038	3/8"	5/8" - 11	2.75"	5000	Medium
CUDB012	1/2"	5/8" - 11	2.75"	5000	Medium
CUDB058	5/8"	5/8" - 11	2.75"	5000	Medium
CUDB034	3/4"	5/8" - 11	2.75"	5000	Medium

RECOMMENDED TILE BIT OPERATING INSTRUCTIONS

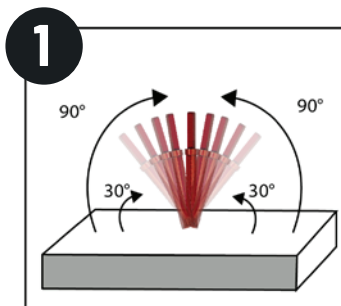

Angle core bit to 30°. Begin drilling and slowly move to 90°.

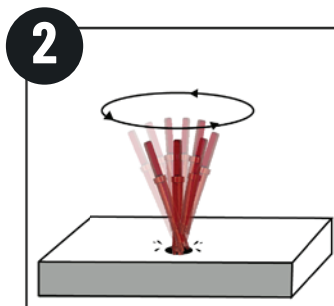

Oscillate core bit as you drill into the material. Keep drilling speed constant.

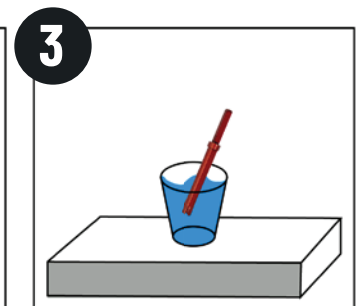

After completing hole, cool down in water and remove any material stuck in core. Do not force or overheat while in use.

TILE & GLASS

CYCLONE PORCELAIN TURBO BLADE

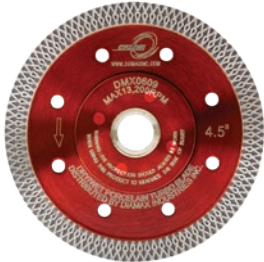

The new mesh turbo rim minimizes heat caused by friction

Cooler rim temperatures increase life and speed of your cut

New diamond bond makes this the best continuous rim ever

60mm to 1" arbor reducer bushings are available for larger blades

TOOLS: ANGLE GRINDER, HAND SAW
MATERIALS: PORCELAIN/TILE, ULTRA-COMPACT

ITEM #	SIZE	ARBOR	RPM
TBP35	3.5"	5/8"- 7/8"- 20mm, reinforced hub	13200
TBP40	4"	5/8"- 7/8"- 20mm, reinforced hub	13200
TBP45	4.5"	5/8"- 7/8"- 20mm, reinforced hub	13200
TBP50	5"	5/8"- 7/8"- 20mm, reinforced hub	12200
TBP60	6"	5/8"- 7/8"- 20mm, reinforced hub	10000
TBP70	7"	5/8"- DKO, reinforced hub	8600
TBP7Q	7"	5/8"- 7/8"- 20mm, reinforced hub	8600
TBP100	10"	5/8"- 7/8"- 1"	6100
TBP1260	12"	50/60mm, reinforced hub	6300
TBP1460	14"	50/60mm, reinforced hub	5400
TBP1660	16"	50/60mm	4800

CYCLONE CONTINUOUS RIM BLADE

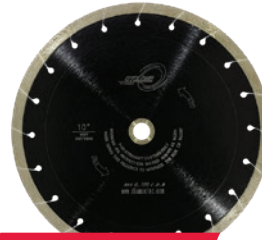

IMPROVED

New reinforced Hub!

Most versatile blade that cuts granite, marble, porcelain, and ceramic tile

Also used widely in counter top fabrication for granite, engineered stone and marble

Ideal for cleaning seams and preparing material for miter joints

Slotted for more aggressive cutting with minimal chipping

TOOLS: ANGLE GRINDER, HAND SAW
MATERIALS: ENGINEERED STONE, GRANITE, MARBLE, PORCELAIN/TILE, ULTRA-COMPACT

ITEM #	SIZE	ARBOR	RPM
CSR040	4"	5/8"- 7/8"- 20mm	15300
CSR045	4.5"	5/8"- 7/8"- 20mm	13200
CSR050	5"	5/8"- 7/8"- 20mm	12200
CSR060	6"	5/8"- 7/8"- 20mm	10000
CSR070	7"	5/8"- DKO	8600
CSR080	8"	5/8"- 7/8"- 20mm	7500
CSR100	10"	5/8"- 7/8"- 1"	6100
CSR120	12"	5/8"- 7/8"- 1"	6300
CSR140	14"	5/8"- 7/8"- 1"	5400

CYCLONE ELECTROPLATED PAD

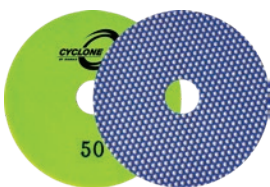

Electroplated diamonds on thin pad provides excellent flexibility

Last about 150 times longer than general sandpaper

Excellent option for honing

Wet use only

TOOLS: ANGLE GRINDER, AIR POLISHER
MATERIALS: GRANITE, MARBLE, PORCELAIN/TILE, QUARTZITE, ULTRA-COMPACT

ITEM #	SIZE	GRIT	BOND	MAX RPM
PDE450	4"	50	Electroplated	3000
PDE4100	4"	100	Electroplated	3000
PDE4200	4"	200	Electroplated	3000
PDE4400	4"	400	Electroplated	3000
PDE4800	4"	800	Resin	3000
PDE41500	4"	1500	Resin	3000
PDE43000	4"	3000	Resin	3000

CYCLONE CONTINUOUS RIM GLASS BLADE



Diamond bond specifically made for glass tile

For clean and precise cuts in glass

Cuts glass and white backing chip-free

For wet cuts only

TOOLS: ANGLE GRINDER, HAND SAW
MATERIALS: GLASS

ITEM #	SIZE	ARBOR	RPM
CRGB045	4.5"	5/8"- 7/8"	13300
CRGB07	7"	5/8"- DKO	8500
CRGB10	10"	5/8"- 7/8"- 1"	6100

ACCESSORIES

ADAPTERS



CNCADP



CBADPTR



BA4H

We carry a wide range of adapters. These are our most common. If you require something special please contact us.

ITEM #	DESCRIPTION
BA4H	4 hole adapter for blade with 5/8" - 11 female thread
CBADPTR	1/2" shaft to 5/8"- 11 male thread
CNCADP	5/8"- 11 male to 1/2" gas CNC male adapter

APRON



Waterproof design

Vinyl material

One size only

ITEM #	DESCRIPTION
APRON	Cyclone waterproof apron

CYCLONE BACKER PADS

Backer pads are available in 3", 4", and 5"

Choose from soft or hard rubber, ultra thin or hard plastic

New aluminum backer now available in 4"



3" RUBBER BACKER

4" RUBBER BACKER

5" RUBBER BACKER

TOOLS: ANGLE GRINDER, AIR POLISHER

ITEM #	SIZE	BODY	DESCRIPTION	FITTING
BP30	3"	Soft rubber	Velcro backer pad	5/8"- 11
BPR30	3"	Firm rubber	Velcro backer pad	5/8"- 11
BPC40	4"	Soft rubber	Velcro backer pad	5/8"- 11
BPR40	4"	Firm rubber	Velcro backer pad	5/8"- 11
BPP40	4"	Hard plastic	Velcro backer pad	5/8"- 11
BPT40	4"	Soft rubber	Velcro backer pad	5/8"- 11
BPA40	4"	Aluminum	Velcro backer pad	5/8"- 11
BP50	5"	Soft rubber	Velcro backer pad	5/8"- 11
BPR50	5"	Firm rubber	Velcro backer pad	5/8"- 11
BPSL40T	4"	Hard plastic	Velcro backer pad	Snail lock
BPSL50	5"	Hard plastic	Velcro backer pad	Snail lock
BPSL60	6"	Hard plastic	Velcro backer pad	Snail lock



BPC40

BPT40

BPP40











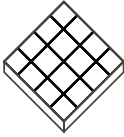

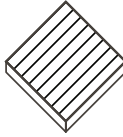
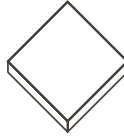
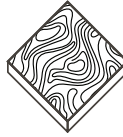
BPA40

BPSL40T

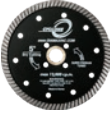
SNAIL LOCK BACKER

TURBO BLADES

	 PORCELAIN /TILE	 ENGINEERED STONE	 GRANITE	 QUARTZITE	 ULTRA-COMPACT	 GLASS	 MARBLE
 Cyclone Continuous Rim Blade	★★★	★★	★★	★★	★★★★	★★	★★★★
 Cyclone Porcelain Turbo Blade	★★★	★★	★★	★★	★★★★	★★	★★
 Cyclone Side Segment Turbo Blade		★★★★	★★	★★			
 Cyclone Turbo Blade		★★	★★★★	★★			
 Hurricane Turbo Blade		★★	★★★★	★★			
 Cyclone S Arrowtek Turbo Blade		★★	★★★★	★★★★			
 Super Cyclone Electroplated Blade	★★	★			★★★★	★★★★	★★★★
 Typhoon Turbo Blade		★★	★★★★	★★			

TROUBLESHOOTING

BLADE

Blade worn out of round: Shaft bearings are worn / Blade arbor is damaged from previous improper mounting

Remedy: Install new blade shaft as required / Replace worn shaft or mount an arbor reducer

Blade will not cut: The bond is too hard for the material being cut / Blade has become dull (glazed) as a result of being used on too hard of a material / Machine has insufficient horsepower / Cutting is slow

Remedy: Use a blade with a softer bond / Glazed blades can be re-opened by cutting a soft, abrasive material such as concrete / Change to a lower horsepower blade

Uneven Segment Wear: Insufficient water (usually on one side of the blade) / Equipment defects cause the segments to wear unevenly / Saw is improperly aligned

Remedy: Flush out water system and check flow and distribution to both sides of the blade / Replace bad bearings, worn arbor or misalignment to the spindle / Check saw head aligned for squareness both vertically and horizontally

Arbor hole out of round: Blade collar is not tightened, allowing blade rotation or vibration of shaft / Blade collar is not tightened, allowing blade cramping / Blade is not properly mounted

Remedy: Tighten the shaft nut with your wrench to make certain the blade is adequately secured / Clean blade collars, making certain they are not worn / Make sure the blade is mounted on the proper shaft diameter before tightening the shaft nut

Segment cracks: The bond is too hard for the material being cut

Remedy: Use a blade with a softer bond

Blade wobbles: Blade is running at improper speed / Blade collar diameters are not identical / Blade is bent as a result of dropping or twisting

Remedy: Make certain the blade shaft is running at the recommended RPM to match tensioned speed of the blade / Check

blade collars to make sure they are clean, flat, and the correct diameter / Get a new blade or have the blade re-tensioned

Segment loss: Overheating due to lack of water / Steel center is worn from undercutting / Defective blade collars are causing improper blade alignment / Bond is too hard for material being cut / Blade is cutting out of round, causing a pounding motion improper blade tension

Remedy: Check water feed lines and make sure water flow is adequate on both sides / Use sufficient water to flush out the cut / Clean blade collars or replace / Use a blade with a softer bond / Replace worn bearing / Ensure blade is running at a correct RPM and that the blade is tensioned for correct RPM

Cracks in Steel Center: Blade flutters during cutting as a result of losing tension / Blade specification is too hard for the material being cut / Bad blade shaft bearing / Steel center has been overheating as a result of blade spinning on arbor

Remedy: Tighten the shaft nut and have the blade re-tensioned / Use softer bond to eliminate stress which created cracks / Replace bad shaft bearing / Check water flow, distribution and lines, and make sure to tighten blade shaft nut

Loss of tension: Steel center has been overheating from rubbing the side of the material being cut / Unequal pressure at the blade clamping collars / Bond is too hard for material being cut

Remedy: Make certain the blade RPM is correct so the blade operates at its tensioned speed / Blade clamping collars must be identical in diameter and the recommended size / Use a blade with a softer bond

DRY POLISHING DISK

Disk has short life during polishing: RPMs are too high

Remedy: Polish dry at constant 2000 RPM & wet at 3000 RPM (Dryflex 5: Polish wet or dry at constant 4000 RPM)

Disk burns the stone: RPMs too high during polishing

Remedy: Polish wet or dry at constant 4000 RPM

Disk leaves a dull finish: Low RPM and/or time spent polishing per step

Remedy: Polish wet/dry at 4000 RPM and/or polish with more time.

Disk is coming apart: Disk is new and used too aggressively

Remedy: Polish flat edges first before complex edges

Tread comes apart: Polishing over sharp corners

Remedy: Grind down or avoid polishing sharp corners

Velcro comes apart: Constantly pulling disk off backer pad by tread instead of velcro

Remedy: Pull pad off backer pad by velcro

Disk is not staying fixed to backer pad: Velcro on backer pad and or on disks is exhausted Remedy: Replace with new backer pad and/or replace with new polishing disk

Disk bleeds and or burns the stone: RPMs too high during polishing

Remedy: Polish dry at constant 2500 RPM and wet polish at 3000 RPM

Disk does not polish: Not enough diamond contact on stone surface

Remedy: Expose more diamonds in resin with a dressing stone

Resin bleeds on stone surface: Not enough water supply used during polishing

Remedy: Increase water disbursement out of machine

WET POLISHING DISK

Disk does not polish: Not enough diamond contact on stone surface

Remedy: Expose more diamond contact from resin with a dressing stone

TROUBLESHOOTING

Disk has short polish life: RPMs are too high when polishing and or not enough water dispersed

Remedy: Polish with consistent 3500-3000 RPMs with substantial water disbursement on stone

Disk leaves scratches on stone: Polishing too fast with lower grit disks, which may leave noticeable scratches

Remedy: Spend more time polishing at lower grits to effectively avoid scratching

Disk is not staying fixed to backer pad: Velcro on backer pad and or on disks is exhausted

Remedy: Replace with new backer pad and or replace with new polishing disk

CORE DRILL BIT

Segment Loss: Core bit dropped / RPM is too high causing weld to melt and segments to detach from core / Not enough water to cool drilling process
Remedy: Replace with new bit. Using a bit with a missing segment can be dangerous / Spin at recommended RPM depending on the diameter and style of bit

Bit not drilling and or "turning blue": Segments glazed over / RPM is too high / Not enough water to cool drilling process

Remedy: Expose more diamond on segment with a dressing stone / Spin at a recommended RPM depending on the diameter and style of bit / Increase water while drilling / Drill into stone at an angle then keep at a consistent 90 degree angle on stone

Segments rounding: Constant boring or maneuvering grinder in excess of 90 degrees around stone

Remedy: Drill into stone at an angle then keep at a consistent 90 degree angle on stone

GRINDERS/SHAPERS

Cyclone V1 – Not cutting or grinding but still can see diamonds: Vacuum

braised technology is a process where the diamonds are all exposed on the metal therefore what you see on the tool is all the diamond contained / Flat grinding on stone
Remedy: Replace with a new V1 - diamond sharpness is used up / Replace with a new V1 and use only for edge shaping

Cyclone V2'S – Not grinding but still can see diamonds: Vacuum braised technology is a process where the diamonds are all exposed on the metal therefore what you see on the tool is all the diamond contained / Flat grinding on stone

Remedy: Replace with a new V2 because diamond sharpness is used up / Replace with a new V2 and use tool only for edge shaping and maneuver disk in a circular motion

Cyclone Stock Removal Wheels – Uneven groove like wear in wheel: Stock removing in a constant position

Remedy: Osculate wheel up and down for even wear on wheel

Wheel vibrating/bouncing on stone: Uneven wear on wheel

Remedy: Osculate wheel up and down for even wear on wheel or reshape with a dressing stone

Wheel not removing stock aggressively: Stone dust hindering the sinter

Remedy: Change to coarser grit or redress tool with a dress stone

Wheel removing stock too aggressively: Grit being used is too aggressive

Remedy: Change to finer grit

Cyclone Zero Tolerance Wheels – Uneven groove like wear in wheel: Stock removing in a constant position

Remedy: Osculate wheel up and down for even wear on wheel

Bottom segments or resin chipping Cause: Dropping of wheel on the ground

Remedy: Replace with a new wheel using it can result in chipping the stone and even personal injury

Cyclone Turbo Cup Wheel – Cup wheel not grinding or turning blue: Cup wheels spinning above the recommended RPM / Not using enough water to cool the cup wheel during the grinding process.

Remedy: Expose more diamonds on the segment with a dressing stone / Spin at the recommended RPM / Increase the amount of water used during grinding

Cyclone Finger Bit – Grooves in finger bit: Finger constantly being used in the same place

Remedy: Osculate bit up & down for even wear

Finger bit wearing in the middle: Finger constantly being used in the same place

Remedy: Osculate bit up and down for bit to wear evenly

Finger bit breaking: Bit constantly used in the same place with strong feed rate

Remedy: Slow down feed rate on hard granite. You may use faster feed rate on softer granite

Melting of finger bit thread: Bit not properly inserted or CNC cone defective

Remedy: Replace CNC cone or thread in finger bit accurately

Cyclone Router Bits – Router bit not shaping: RPM is too fast on stone

Remedy: Spin at recommended RPM

Router bit is getting uneven grooves inside: More edge prepping needed before Pos. 1

Remedy: Prep the edge of the stone with a cup wheel and/or a Pos. 0

Cyclone 6 Step Snail Lock Cup Wheels – Not effectively doing straight edge polishing: Our snail lock cup wheels are designed for beveling and bull nosing Remedy Use an appropriate tool for straight edge polishing

THE EYE OF INNOVATION

WITH MORE THAN 25 YEARS OF EXPERIENCE, DIAMAX STRIVES TO BE THE #1 IN INNOVATION, QUALITY, AND CUSTOMER SERVICE.

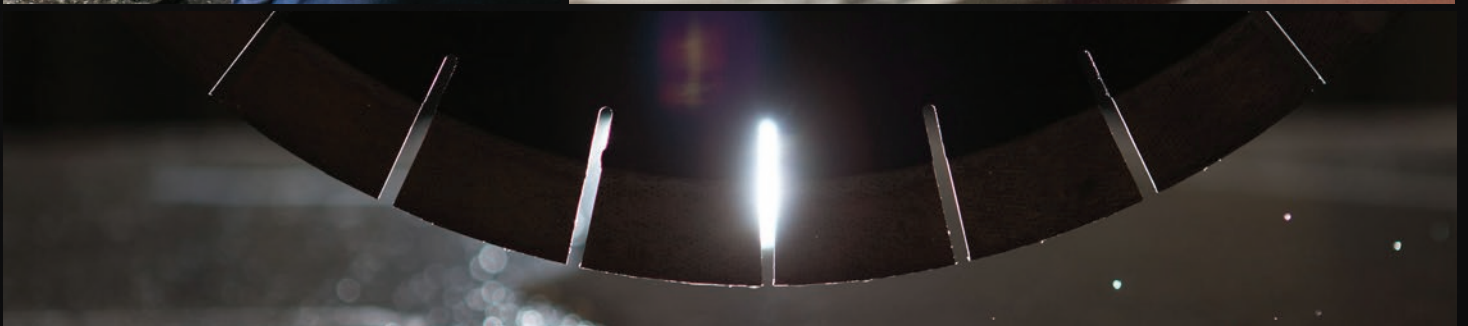

DIAMAXINC.COM

1.888.449.0502



@DIAMAXINC

ALL CONTENT © DIAMAX INDUSTRIES INC.